



Security Tech Germany



MOBILE SECURITY

CATALOGUE 2025

100 YEARS
1924-2024

Advantages of the new 2025 catalogue

- Find products quicker and more easily
- Product features instantly visible



Learn more inside!

PICTOGRAMS



New product



New colour

LOCKS



Double locking

Dual locking of the shackle in the lock body



Pocket size

Lock in small format



XL size

Lock in large format



LED key

Illuminated LED key



Automatic locking

No active locking with a key required



Robust webbing

High-tech mesh, durable and hydrophobic



Individual code

Combination code can be freely selected



Rechargeable

Rechargeable battery



Universal fitting

Thanks to the variable mounting slots the lock can be attached to all common frame fittings



Battery

Including battery



Flexible loop

Two infinitely adjustable loops allow best possible use of the locking range



Protected against battery angle grinders

Wolfram-Carbid reinforced to protect against attacks with battery angle grinders



SmartX

Innovative locking system, controlled via smartphone



XPlus

Picking-resistant disc cylinder „XPlus“



Lightweight

Lightweight lock, ideal for performance riders



Alarm

Lock with 100 dB alarm function



Fingerprint

Easy to open with a fingerprint



Waterproof lockbody

Waterproof lock body to protect the electronics from moisture damage



OEM

Locks are delivered without sales packaging so they can be mounted more quickly. Ideal for use in workshops



One Key Option

Multiple locks can be produced keyed alike and thus operated with one key

HELMETS



Bug mesh

Full protection from insects



Ponytail compatibility

Perfect fit for people with long hair



Half-ring

Adjustable ring connected to adjustment system enclosing half of the head



Full-ring

Adjustable ring connected to adjustment system enclosing all of the head



ActiCage

Structural reinforcement integrated into the EPS to optimize stability



XL Size

Large helmet sizes available (62+ cm)



Ventilation

Number of air intakes and outlets



ABUS

DESIGNED & ENGINEERED
IN GERMANY

ABUS

ABUS

CONTENT

ABUS - Made in Germany	004
Approvals	005
ONE KEY	006
Key Service	010
Lock Selector	012
U-Shackle locks	014
Folding locks	026
Chain locks	044
Goose Lock	070
Steel-0-Flex locks	074
Coil cable and cable locks	082
Frame locks and battery locks	098
Special security	112
Brackets and Bags	136
ABUS OEM	156
Road	162
MTB	186
Urban	206
Kids	254
Helmet accessories	276
Lumino	286
Shop in Shop	296
Notes	302
Index	305
General Terms and Conditions	307



ABUS - MADE IN GERMANY

When August Bremicker and his sons founded ABUS in 1924, they had a lot of experience with engineering and craftsmanship – as well as a very clear vision: They wanted to create products that protected human life and property. It was a far-sighted corporate goal – paired with an expectation for quality right from the start. It was the start of a continuous success story. The ABUS brand became a synonym for security world-wide.



HIGH-QUALITY MATERIALS

To be able to offer consistently high quality and security against every type of brutal and intelligent attack technique, we use the highest-quality materials at every price level. Complex hardening processes guarantee the best resistance in our materials. Our internal quality management check all materials before and during the production process to ensure every product has the high quality you demand.

THE KEY TO SUCCESS

At ABUS, we design and build the tools and machines used in the production of our products in-house. That bundles knowhow, guarantees jobs, and strengthens identification. Our own engineering and toolmaking department concentrates exclusively on the development of bicycle and motorcycle locks. This ensures that we meet the tough requirements you place on your bicycle or motorcycle lock every day.

ENSURING CONSISTENCY

In our own ABUS test laboratory, we routinely carry out tests and attacks on our products to ensure our products offer consistently high quality.

Among others we make sure our locks are resistant to:

- Ice spray attacks and freezing conditions at -40°C
- Twisting, pulling, hammering and sawing attacks with help of our manual or machine tests
- Rust by simulating highly corrosive weather conditions

Made in Germany

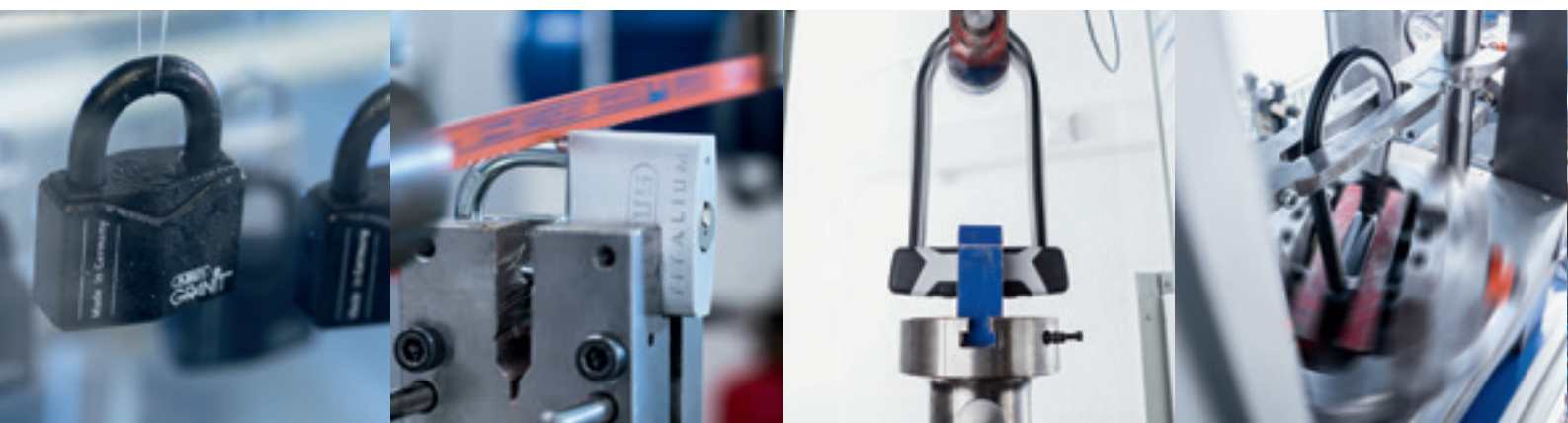

APPROVALS

ABUS locks are tested and approved by independent testing institutions in a number of European countries. As every test lab use different tools, techniques and machines to test both security and quality we are very proud of the high number of different approvals given to ABUS products. If a lock can pass the varying test requirements in many different countries you can be sure it is of the highest possible quality and security.

The following seals of approval confirm the outstanding security of ABUS cycle locks:



Svensk Brand- och
Säkerhetscertifiering AB
Stockholm, Sweden



Norges Forsikringsforbund
Oslo, Norway



Dansk Varefakta Naevn
Copenhagen, Danmark



Finanssiala
Helsinki, Finland



ART (ANWB, RAI, Theft Insurers)
Nieuwegein, The Netherlands



Sold Secure
Rugby, Great Britain



FUB 2-roues
Valence, France



Test Seal VdS
Cologne, Germany



ABUS Seal for Ice Spray Test
Volmarstein, Germany





ONE KEY™ SIMPLE . INDIVIDUAL .

HAVE CUSTOM BIKE LOCKS MADE - OPERATE EVERYTHING WITH JUST ONE KEY!

A primary lock, a frame lock, a padlock, and even a battery lock for e-bikes - if you want to secure your bike properly, you need a lot of locks. That is why we at ABUS, with the ONE KEY system, offer the ability to produce locks for your customers in such a way that they can all be operated with one key. No mess, no looking for keys.

HOW ONE KEY™ WORKS

It's quite simple. Each ABUS lock has an individual key code with which spare keys or matching "keyed alike" locks can be made - even years after purchase. All that matters is that the locks from ABUS have the same type of cylinder installed.

HERE'S HOW IT WORKS



The order is conveniently placed via the Partner-Portal.

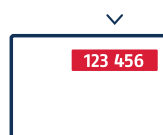

1. Read key code from code card



2. Choose suitable products at your retailer



3. 1 week to manufacture your custom product



4. Pick up at retailer or ship to home



FAMILIAR FACE – NEW DESIGN

As a manufacturer of cylinders and bicycle locks, ABUS has the unique opportunity in the market to manufacture custom locks so that they can all be operated with one key – or “keyed alike”. It is important that the locks be compatible with each other for this purpose.

So far we have marked our products and campaigns with these icons:



With YourPlus™, we have combined all locks that have a Plus cylinder.

This icon currently indicates that this lock can be keyed alike.

FROM NOW ON, WE'RE BRINGING EVERYTHING TOGETHER UNDER ONE KEY™ – A CLEAR PROMISE FOR MORE CONVENIENCE.

OVERVIEW OF KEYED ALIKE PRODUCTS

PRODUCTS WITH XPLUS CYLINDER

GRANIT™ Super Extreme 2500
 GRANIT™ Extreme 59
 GRANIT XPlus™ 540
 BORDO GRANIT XPlus™ 6500K
 BORDO GRANIT XPlus™ 6500KA
 BORDO™ 6200K
 BORDO™ 6000K
 BORDO™ 6000KA
 Steel-0-Chain™ 9809K
 Steel-0-Chain™ 9808K
 GRANIT City Chain XPlus™ 1060
 6950M XPlus™
 WCH90

PRODUCTS WITH PLUS CYLINDER

GRANIT™ Plus 640
 GRANIT™ Plus 470
 CityChain™ 1010

EC CYLINDER

GRANIT™ 460
 PHANTOM™ 8960

Surcharge
 for manufacturing
 only 10%
 of the price
 of the lock



MAXIMUM CONVENIENCE FOR YOUR CUSTOMERS

- + no frustrating searching for the right key
- + for e-cyclists with battery lock, frame lock, bike lock
- + for families with multiple locks
- + for couples or friends sharing their bike

ONE KEY PRICE LIST

U-SHACKLE LOCKS

98210	2500/165AB230 +USH2500 gl. Granit Super Extreme
95475	540/160HB300+SH B gl. One Key GRANIT XPLUS
95474	540/160HB230+SH B gl. One Key GRANIT XPLUS
04409	540/160HB300+EaZy KF gl. One Key GRANIT XPLUS
04407	540/160HB230+EaZy KF gl. One Key GRANIT XPLUS
04410	540/160HB300+USH540 gl. One Key GRANIT XPLUS
04408	540/160HB230+USH540 gl. One Key GRANIT XPLUS
70665	540/160HB300 gl. One Key GRANIT XPLUS
04411	540/160HB230 gl. One Key GRANIT XPLUS
81461	640/135HB230 BK TexKF gl. One Key GRANIT PLUS
81460	640/135HB150 BK gl. One Key GRANIT PLUS
81459	640/135HB150 BK/RD gl. One Key GRANIT PLUS
95473	470/150HB300+SH B gl. One Key GRANIT PLUS
95472	470/150HB230+SH B gl. One Key GRANIT PLUS
81464	470/150HB300+EaZy KF gl. One Key GRANIT PLUS
81462	470/150HB230+EaZy KF gl. One Key GRANIT PLUS
81465	470/150HB300+USH gl. One Key GRANIT PLUS
81463	470/150HB230+USH gl. One Key GRANIT PLUS
95471	460/150HB300+SH B gl. One Key GRANIT
95470	460/150HB230+SH B gl. One Key GRANIT
04417	460/150HB300+USH gl. One Key GRANIT
04416	460/150HB230+USH gl. One Key GRANIT

FOLDING LOCKS

67593	6500K/120 BK SH gl. One Key BORDO Granit XPlus
91203	6500K/90 BK SH gl. One Key BORDO Granit XPlus
64172	6500KA/90 BK SH gl. One Key BORDO Granit XPlus
41654	6200K/90 SH BK gl. One Key BORDO
67533	6000K/120 BK SH gl. One Key BORDO Big

FOLDING LOCKS

67509	6000K/90 BK SH gl. One Key BORDO
67464	6000K/120 BK ST gl. One Key BORDO Big
67463	6000K/90 BK ST gl. One Key BORDO
67614	6000KA/120 BK SH gl. One Key BORDO Big Alarm
67608	6000KA/90 BK SH gl. One Key BORDO Alarm
81380	6000/120 BK SH gl. One Key BORDO Big
72987	6000/90 BK SH gl. One Key BORDO
83747	6000A/120 BK SH gl. One Key BORDO Big Alarm
80940	6000A/90 BK SH gl. One Key BORDO Alarm
34572	5900/90 BK ST gl. One Key BORDO Classic
78065	6055K/60 BK gl. One Key BORDO LITE MINI
82573	6055K/60 MOVISTAR gl. One Key BORDO LITE MINI
82574	6055K/60 RD gl. One Key BORDO LITE MINI

CHAIN LOCKS

42277	1060/170 gl. One Key City Chain XPlus
42275	1060/140 gl. One Key City Chain XPlus
30595	1060/110 gl. One Key City Chain XPlus
42276	1060/85 gl. One Key City Chain XPlus
21578	1010/170 black gl. One Key City Chain
21577	1010/140 black gl. One Key City Chain
21576	1010/110 black gl. One Key City Chain
71549	1010/85 black gl. One Key City Chain
95555	9809K/140 BK gl. One Key Steel-0-Chain
95556	9809K/170 BK gl. One Key Steel-0-Chain
95554	9809K/110 BK gl. One Key Steel-0-Chain
95553	9809K/85 BK gl. One Key Steel-0-Chain

CHAIN LOCKS

97171	9808K/170 BK gl. One Key Steel-0-Chain
97170	9808K/140 BK gl. One Key Steel-0-Chain
97169	9808K/110 BK gl. One Key Steel-0-Chain
97172	9808K/85 BK gl. One Key Steel-0-Chain

STEEL-0- FLEX LOCKS

77088	8960/110 TexFL gl. One Key PHANTOM
78593	8960/85 KF gl. One Key PHANTOM

FRAME LOCKS

96220	6950M AM NR BK OE gl. One Key XPLUS
95905	6950M AM R BK OE gl. One Key XPLUS
96218	6950ML NR BK OE gl. One Key XPLUS
96219	6950ML R BK OE gl. One Key XPLUS
90764	5955 NR BK gl. One Key PRO SHIELD XPLUS
91147	5955 R BK gl. One Key PRO SHIELD XPLUS
91145	5755L NR BK OE gl. One Key SHIELD XPLUS
91146	5755L R BK OE gl. One Key SHIELD XPLUS
79846	5950 NR BK gl. One Key PRO SHIELD
87766	5950 R BK gl. One Key PRO SHIELD
81477	5750L NR BK gl. One Key SHIELD PLUS
81476	5750L R BK gl. One Key SHIELD PLUS

BATTERY LOCKS

95510	BLO BOS IT3 XPlus OE gl.
95511	BLO BOS IT2.1 XPlus OE gl.
83447	BLO BOS IT2.1 PLUS gl.
90730	BLO BOS DT3 XPlus OE gl.
68734	BLO BOS DT2 XPlus OE gl.
81479	BLO BOS DT2 PLUS gl.
90913	BLO BOS RT2 XPlus OE gl.

BATTERY LOCKS









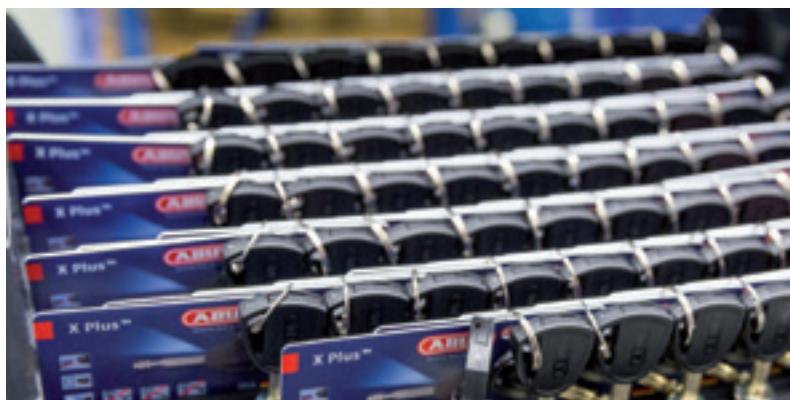





73289	BLO BOS RT2 PLUS gl.
91226	BLO CUB IT2.B3 XPlus OE gl.
91225	BLO CUB IT2 XPlus OE gl.
96627	BLO CUB IT2 Plus OE gl.
91224	BLO CUB IT1.B3 XPlus OE gl.
91223	BLO CUB IT1 XPlus OE gl.
95514	BLO CUB IT1 PLUS OE gl.
95529	BLO KTM IT1 XPlus OE gl.
95512	BLO SHI IT2 XPLUS OE gl.
95519	BLO SHI IT2 PLUS OE gl.
83451	BLO SHI DT1 PLUS OE gl.
95521	BLO WIN IT4 PLUS OE gl.
87544	BLO WIN IT3 PLUS OE gl.
87543	BLO WIN IT2 PLUS OE gl.
87542	BLO WIN IT1 PLUS OE gl.
95520	BLO ZEG IT5 PLUS OE gl.
95513	BLO ZEG IT4 XPlus OE gl.
95517	BLO ZEG IT4 PLUS OE gl.
95516	BLO ZEG IT3 PLUS OE gl.



















KEY SERVICE

The ABUS key service allows you to order new keys for existing locks.

Just select the required blank, enter the desired coding and the key will be delivered within no time.



	Cylinder type	EAN-No.:	Item no
	XPlus (illuminated key)	4003318357565	35756 5
	XPlus	4003318246579	24657 9
	Plus (illuminated key)	4003318357572	35757 2
	Plus	4003318062278	06227 8
	8N	4003318816635	81663 5
	6N	4003318709777	70977 7
	6S	4003318995095	99509 5
	T82	4003318561139	56113 9
	T83	4003318844867	84486 7
	F82	4003318815263	81526 3
	P82	4003318827044	82704 4
	E6	4003318822452	82245 2
	KC 54	4003318815270	81527 0
	ML54	4003318815287	81528 7

	Cylinder type	EAN-No.:	Item no
	NW52 black	4003318546938	54693 8
	NW72 red	4003318547539	54753 9
	PL1	4003318818684	81868 4
	RH 5	4003318835957	83595 7
	RH EC	4003318267666	26766 6
	U72	4003318815294	81529 4
	U73	4003318815300	81530 0
	U74	4003318815317	81531 7
	V61	4003318815324	81532 4
	V62	4003318815348	81534 8
	V63	4003318815331	81533 1
	V64	4003318815355	81535 5
	V65	4003318815362	81536 2
	Z72	4003318815379	81537 9
	Z73	4003318815386	81538 6
	Z74	4003318815393	81539 3
	ABUS - Voucher for Plus or XPlus	4003318043185	04318 5
	ABUS - Voucher for ABUS other	4003318290015	29001 5

THE ABUS LEVEL SYSTEM

Finding the right lock for your customer requires a few questions that can help in the selection process. A lock must not only be secure, it must also suit the user.

The questions below can help you figure out what your customer is looking for:

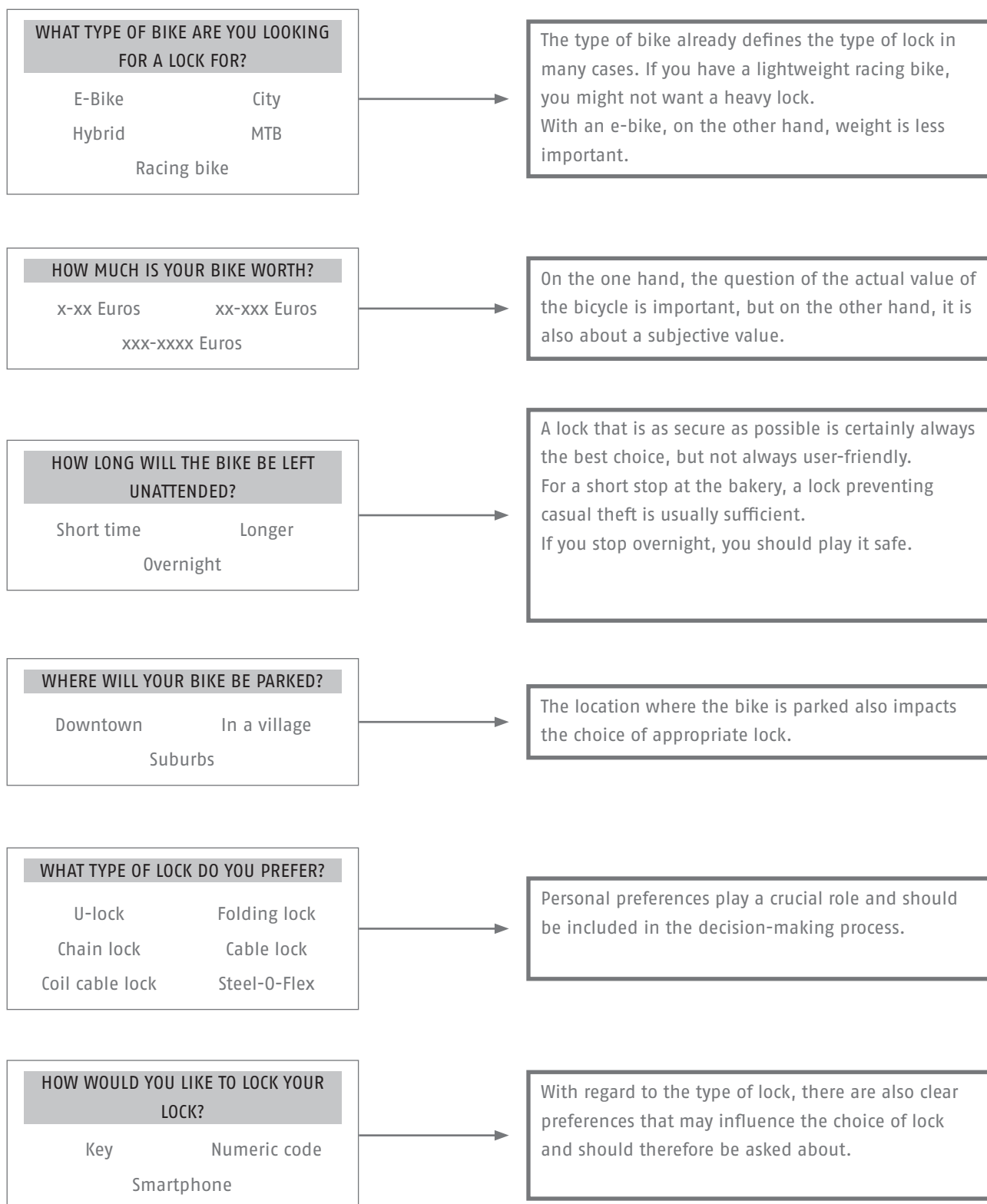

In the sales conversation, you get the best feel for your customer and a sense for what they value.

Many questions are rather soft factors and have an influence on the choice of the lock, but not so much on the choice of the appropriate security level.

The most important factors in determining the level of protection required are the bicycle value, location and length of time the bike is left.

For this, we recommend the following reference:

	Rural region 	Suburban 	Urban 
Quickstop	2 - 4	7 - 10	13 - 15
Few hours	5 - 6	10 - 13	13 - 15
All day	6 - 7	13 - 15	15
Overnight	7 - 10	15	15

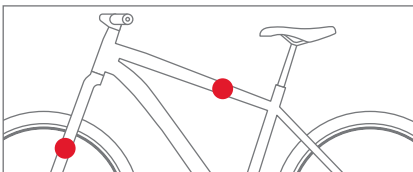

Lock your bike in illuminated and well frequented areas.

Secure you bike to an immovable object and lock both, frame and front wheel.

Keep the lock as high as possible and pass it through the frame as much as you can. This makes it harder to attack.

U-SHACKLE LOCKS



**GRANIT™
SUPER EXTREME 2500**



black

Page 16

GRANIT XPLUS™ 540



black

Page 18

GRANIT™ PLUS 640



red

Page 19



black

Page 19

GRANIT™ PLUS 470



black

Page 20

ULTIMATE 420K



red

Page 21

GRANIT™ 460



black

Page 22

ULTRA 410K



green

Page 24



purple

Page 24

FACILO 32



black

Page 25

402



yellow

Page 25

GRANIT™ SUPER EXTREME 2500

SECURITY LEVEL



FEATURES



Visit our campaign website

TECHNICAL DATA

- Hardened 27 mm square parabolic shackle with plastic coating
- The lock shackle and body are better protected against brutal cutting attacks by battery angle grinders thanks to a special tungsten carbide compound material
- Double locking of the shackle in the lock body
- The shackle, housing and structural parts of the locking mechanism are made of specially hardened steel
- ABUS XPlus™ cylinder for extremely high protection against manipulation, e.g. picking
- ABUS Power Cell technology offers maximum protection against impacts and attempts to break open the lock
- Two keys included in the scope of delivery
- ABUS Code Card for spare and replacement keys
- Flexible and firm holder fixation with coated metal fixing straps

TECHNOLOGY



TEST SEALS



1) VK 38886

Ref. No.	EAN 4003318	mm	mm	mm	Weight g	Box Qty
2500/165HB230	99680 1	102	230	27	2230	4
2500/165HB230 + USH2500	96050 5	102	230	27	2470	3



Security Tech Germany



GRANIT SUPER EXTREME 2500

FOR EXTREME SITUATIONS

When we combine our best technologies to create an extreme lock - the result is the GRANIT SUPER EXTREME 2500! Extreme resistance against extreme attacks, even if the opponent is the cordless grinder!

abus.com



WINNER

AWARD 2023

Made in Germany

GRANIT XPLUS™ 540

SECURITY LEVEL



FEATURES



XPlus™



USH 540



SH B



EaZy KF



TECHNICAL DATA

- 13 mm hardened square shaft parabolic shackle
- ABUS power cell technology offers the highest level of protection against impacts and attempts to break open the lock
- The shackle, housing and the structural parts of the locking mechanism are made of specially hardened steel
- ABUS XPlus cylinder for the highest level of protection against tampering, e.g. picking
- Automatic keyhole cover to protect against dirt and corrosion

TECHNOLOGY



TEST SEALS



1) VK 30330

Ref. No.	EAN 4003318				Weight g	Box Qty
		mm	mm	mm		
540/160HB230	11161 7	108	230	17	1500	6
540/160HB300	11179 2	108	300	17	1700	6
540/160HB230 + USH540	11186 0	108	230	17	1650	4
540/160HB300 + USH540	11188 4	108	300	17	1850	4
540/160HB230 + SH B	69076 1	108	230	17	1650	3
540/160HB300 + SH B	69075 4	108	300	17	1850	3
540/160HB230 + EaZy KF	11183 9	108	230	13	1600	4
540/160HB300 + EaZy KF	11185 3	108	300	13	1800	4

GRANIT™ PLUS 640

SECURITY LEVEL



FEATURES



Plus



Bracket TexKF Mini



VERSIONS



HB150 black



HB230 black

TECHNICAL DATA

- Hardened 12 mm round shackle
- The shackle, the lock body and the structural parts of the locking mechanism are manufactured using specially hardened steel
- Priority given to the use of weight-optimised special alloys and lightweight materials
- ABUS Plus cylinder including automatic cover for maximum protection against attempts at manipulation, e.g. picking



TECHNOLOGY



TEST SEALS



1) Only for SE-version (Art.-Nr. 72510) 2) VK 31644

Ref. No.	EAN 4003318	 mm	 mm	 mm	Weight g	Box Qty
640/135HB150 red	39704 2	83	150	15	800	4
640/135HB150 black	39702 8	83	150	15	800	4
640/135HB230 + TexKF black	39703 5	83	230	15	1030	1

GRANIT™ PLUS 470

SECURITY LEVEL



FEATURES



Plus



USH 460/470/32



SH B



EaZy KF

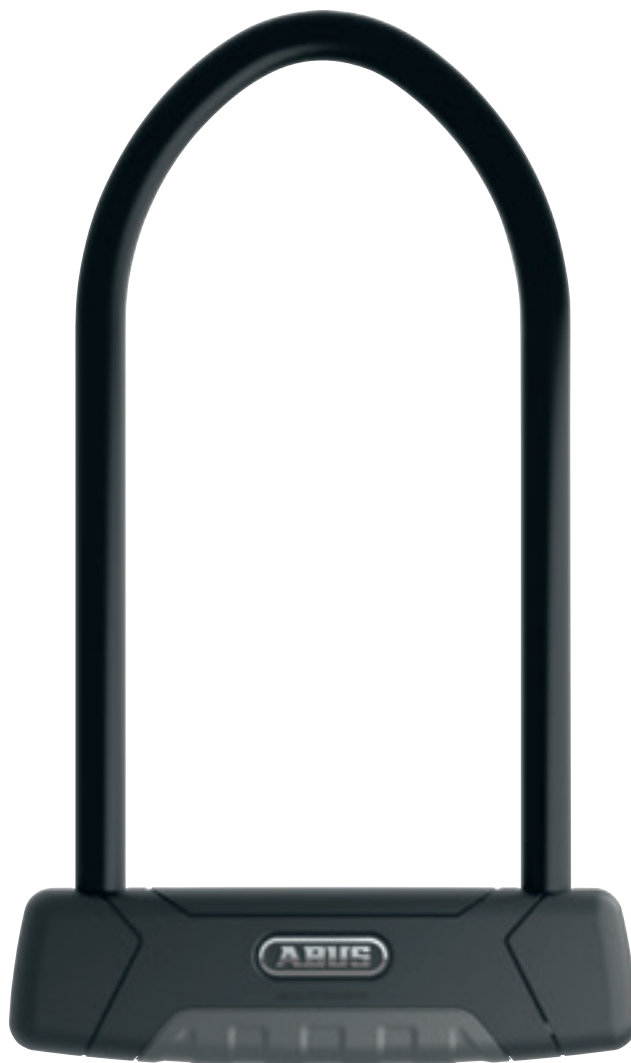

TECHNICAL DATA

- Hardened 12 mm parabolic shackle
- ABUS Power Cell technology provides outstanding protection against attempts to remove the lock by hitting or pulling
- The shackle, the body and the load-bearing parts of the locking mechanism are manufactured from specially hardened steel
- Automatic cover to protect the keyhole from contamination and corrosion

TECHNOLOGY



TEST SEAL



1) VK 30328

Ref. No.	EAN 4003318	mm	mm	mm	Weight g	Box Qty
470/150HB230 + USH470	11249 2	109	230	14	1260	4
470/150HB300 + USH470	11251 5	109	300	14	1320	5
470/150HB230 + SH B	69073 0	109	230	14	1290	3
470/150HB300 + SH B	69072 3	109	300	14	1350	4
470/150HB230 + EaZy KF	11189 1	109	230	14	1240	4
470/150HB300 + EaZy KF	11194 5	109	300	14	1300	4

ULTIMATE 420K

★
NEW

U-Shackle locks

SECURITY LEVEL



FEATURES



USH





TECHNICAL DATA

- Shackle is made of 13 mm thick hardened steel
- High-quality lock cylinder
- Modern design
- Ergonomic lock body coating enables optimum handling
- Colours with high recognition value

TECHNOLOGY



Ref. No.	EAN 4003318	 mm	 mm	 mm	Weight g	Box Qty
420K/150HB140 USH	38113 3	103	140	14	1007	6
420K/150HB140 USH + Cobra™ 10/120	40588 4	103	140	14	1402	6
420K/170HB230 USH	94377 5	103	230	14	1288	6
420K/170HB230 USH + Cobra™ 10/120	40998 1	103	230	14	1609	6

GRANIT™ 460

SECURITY LEVEL



FEATURES



USH 460/470/32



TECHNICAL DATA



- Hardened 12 mm parabolic shackle
- The shackle, the lock body and the structural parts of the locking mechanism are manufactured using specially hardened steel
- ABUS Extra Class cylinder with coded reversible key

TECHNOLOGY



TEST SEAL



Ref. No.	EAN 4003318	 mm	 mm	 mm	Weight g	Box Qty
460/150HB230 + USH460	11253 9	109	230	14	1000	4
460/150HB300 + USH460	11255 3	109	300	14	1250	5



ULTRA 410K

★
NEW

SECURITY LEVEL



FEATURES



Bracket USH134



VERSIONS



410K/150HB140



410K/150HB180



410K/170HB230





410K/170HB230

TECHNICAL DATA

- Hardened 12 mm steel shackle
- High-quality lock cylinder
- Modern design
- Ergonomic lock body coating enables optimum handling
- Colours with high recognition value

TECHNOLOGY



Ref. No.	EAN 4003318	 mm	 mm	 mm	Weight g	Box Qty
410K/150HB140 green SH	94374 4	106	140	12	818	6
410K/150HB140 green SH + Cobra™ 10/120	40996 7	106	140	12	1160	6
410K/150HB180 green SH	41027 7	106	180	12	1240	6
410K/150HB180 green SH + Cobra™ 10/120	94375 1	106	180	12	1240	6
410K/170HB230 green SH	40587 7	106	230	12	1090	6
410K/170HB230 purple SH	38111 9	106	230	12	1090	6
410K/170HB230 green SH+ Cobra™ 10/120	94376 8	106	230	12	1431	6

FACILO 32

FEATURES



USH 460/470/32

SECURITY LEVEL



Ref. No.

EAN
4003318



mm



mm



mm

Weight
g

Box
Qty

32/150HB230 + USH32

37492 0

109

230

12

950

6

32/150HB300 + USH32

37887 4

109

300

12

1160

6



TECHNICAL DATA

- Hardened 12 mm round shackle
- ABUS top-quality locking cylinder
- PVC casing to prevent damage to paintwork

TECHNOLOGY



TEST SEALS



402

FEATURES



Bracket USH 34

SECURITY LEVEL



Ref. No.

EAN
4003318



mm



mm



mm

Weight
g

Box
Qty

402/170HB230 yellow SH34

86742 2

110

230

11

890

6



TECHNICAL DATA

- 11 mm, hardened steel round shackle
- Double-locking mechanism securing the shackle in the lock body
- The shackle, the body and the load-bearing parts of the locking mechanism are manufactured using specially hardened steel
- Special, modern design of the lock body casing allows for optimum handling

TECHNOLOGY



TEST SEALS



FOLDING LOCKS



BORDO™ ONE
6500A



6500A/110
black

Page 30

BORDO GRANIT™
6500KA



6500KA/90
black

Page 31

BORDO GRANIT™
6500K



6500K/90
black

Page 32



6500K/120
black

Page 32

BORDO™
6200K



6200K/90
black

Page 33

BORDO ONE
6000A FINGERPRINT



6000AFP/120
black

Page 34

BORDO™ ONE
6000A



6000A
black

Page 35

BORDO™
6000KA



6000KA/90
black

Page 36



6000KA/120
black

Page 36

BORDO™
6000K



6000K/90
black

Page 37



6000K/120
black

Page 37

BORDO™
6000C



6000C/90
black

Page 38



6000C/120
black

Page 38

BORDO™
6000C LED



6000C/90 LED
black

Page 39

UGRIP BORDO™
5700K



black

Page 40



lime

Page 40



blue

Page 40



red

Page 40

UGRIP BORDO™
5700C



red

Page 41



black

Page 41



blue

Page 41



lime

Page 41

**BORDO™
LITE 6055K MINI**



black

Page 42



red

Page 42



Movistar Team

Page 42

**BORDO™
LITE 6055K**



black

Page 42



red

Page 42

**BORDO™
LITE 6055C MINI**



black

Page 43



red

Page 43



blue SYMBOLS

Page 43



Movistar Team

Page 43



pink SYMBOLS

Page 43

**BORDO™
LITE 6055C**



black

Page 43



red

Page 43

BORDO
6200K

ARLID

ARLID

BORDO™ ONE 6500A

SECURITY LEVEL



FEATURES



Bracket SH BORDO
6500A SmartX



SmartX RC



Can be operated with iOS and Android smartphone or via optional Smart RC remote control (sold separately)



Visit our campaign website

TECHNICAL DATA

- 5.5 mm thick bars, with extra-soft 2-component coating
- Easy operation via the ABUS One app (previously SmartX) – for iOS and Android
- Bike lock can be opened and locked without a key – keyless function based on proven ABUS SmartX™ Bluetooth® technology
- Alarm function with min. 100 dB for 15 seconds, then automatic re-arming
- 3D position detection – detects vibrations and the smallest of movements in all three dimensions and triggers an alarm
- Smart alarm – the lock only emits a short warning tone in the event of minor and brief vibrations, e.g. if a football bounces nearby
- USB-C port
- Storage of the bike's last parking location
- LED light indicates battery and charging status
- RC variant can be operated via included remote control (for all other variants, the remote control is available separately)
- Incl. holder (SH)

TECHNOLOGY



TEST SEALS



Ref. No.	EAN 4003318	 cm	Weight g	Box Qty
6500A/110 black SH BORDO One	61495 8	110	2300	3
6500A/110 black SH RC BORDO One	61497 2	110	2300	3
Bracket SH 6500A One	63488 8		148	1
SmartX™ RC	64000 1		70	1

BORDO GRANIT™ 6500KA

SECURITY LEVEL



FEATURES



Bracket SH 6500K/90



TECHNICAL DATA

- 5.5 mm thick bars, extra-soft coating to prevent damage to paintwork
- The bars and body are made of specially hardened steel
- Alarm function with at least 100 dB for 15 seconds followed by automatic re-arming
- 3-D positional alarm detection - detects shocks and movements in all dimensions
- Smart alarm - the lock only emits a small warning tone in the event of small and short shocks, e.g. if a football hits the bike
- ABUS Link Protection Shield for high protection against attacks on the joints
- Incl. holder (SH)
- ABUS XPlus cylinder for the greatest protection against manipulation, e.g. picking
- Acoustic signal indicates battery status and active status
- Transport position - do not insert the locking bar completely, so that the alarm is inactive
- Alarm position - insert locking bar completely; the alarm will be activated after locking
- Speaker shielded behind the locking bar
- Incl. SH lock carrier for transport on the bike

TECHNOLOGY



TEST SEALS



Ref. No.

Ref. No.	EAN 4003318	cm	Weight g	Box Qty
6500KA/90 black SH	69052 5	90	2020	3
Bracket SH 6500K/90	69051 8		195	3

BORDO GRANIT™ 6500K

SECURITY LEVEL



FEATURES



XPlus™

Bracket SH 6500K/90



VERSIONS



6500K/90 Twinset



6500K/120

TECHNICAL DATA

- 5.5 mm thick bars, extra-soft coating to prevent damage to paintwork
- The bars, housing and the structural parts of the locking mechanism are manufactured from specially hardened steel
- ABUS Link-Protection-Shield offers high protection at the links
- ABUS XPlus cylinder for the greatest protection against manipulation, e.g. picking
- This lock can be made keyed alike to a variety of other locks
- Incl. SH lock carrier for transport on the bike

TECHNOLOGY



TEST SEALS



1) VK 37547

Ref. No.

Ref. No.	EAN 4003318	 cm	Weight g	Box Qty
6500K/90 black SH	61498 9	90	1670	4
6500K/90 black SH TwinSet	61499 6	90	1670 per lock	2
6500K/120 black SH	62115 4	120	2470	3
Bracket SH 6500K/90	69051 8		195	3
Bracket SH 6500K/120	96279 0		230	1

BORDO™ 6200K

NEW

Folding locks

SECURITY LEVEL



FEATURES



Bracket SH 6200K/90



TECHNICAL DATA

- 6.5 mm thick profiled bars (double-T) with coating to protect against paint damage
- The bars, housing and the structural parts of the locking mechanism are made of specially hardened steel
- 360° rotatable lock body for more flexibility when locking
- 94 cm locking circumference
- Including holder SH 6200/90

TECHNOLOGY



TEST SEALS



Ref. No.	EAN 4003318	 cm	Weight g	Box Qty
6200K/90 SH BK	99530 9	90	1320	1
Bracket SH 6200K/90	94474 1		165	3

BORDO™ ONE 6000A FINGERPRINT

SECURITY LEVEL



FEATURES



Bracket SH 6000/120



Fingerprint



TECHNICAL DATA

- 5 mm thick bars, extra-soft coating to prevent damage to paintwork
- 120 cm locking circumference
- Can be operated via fingerprint and ABUS One app
- Up to 8 fingerprints can be taught
- Additional control for other users via the ABUS One app

TECHNOLOGY



Ref. No.	EAN 4003318	 cm	Weight g	Box Qty
6000AF/120 BK SH	99434 0	120	1660	1
Bracket SH 6000/120	61564 1		132	3

BORDO™ ONE 6000A

SECURITY LEVEL



FEATURES



Bracket SH 6000/120



SmartX RC



Can be operated with iOS and Android smartphone or via optional Smart RC remote control (sold separately)



Visit our campaign website

Folding locks

TECHNICAL DATA

- 5 mm thick bars with extra-soft 2-component coating
- Smart locking system with Bluetooth® connection – user-friendly opening and closing without a key via smartphone
- Secure SmartX technology with integration in ABUS One
- Simple and secure integration of multiple users/smartphones
- Alarm function with min. 100 dB for 15 seconds, then automatic re-arming
- 3D position detection – detects vibrations and the smallest of movements in all three dimensions and triggers an alarm
- Smart alarm – the lock only emits a short warning tone in the event of minor and brief vibrations, e.g. if a football bounces nearby
- USB-C port
- Storage of the bike's last parking location
- LED status display
- RC variant can be operated via included remote control (for all other variants, the remote control is available separately)
- Incl. holder (SH)
- CR123A battery

TECHNOLOGY



Ref. No.	EAN 4003318	 cm	Weight g	Box Qty
6000A/120 BK SH BORDO One	97338 3	120	1760	1
6000A/120 BK SH RC BORDO One	97339 0	120	1760	1
Bracket SH 6000/120	61564 1		132	3
SmartX™ RC	64000 1		70	1

BORDO™ 6000KA

SECURITY LEVEL



FEATURES



XPlus™



Bracket SH 6000/90



Bracket SH 6000/120



VERSIONS



6000KA/120 BK SH

TECHNICAL DATA

- 5 mm bars with extra-soft yet resistant coating to prevent damage to paintwork
- The bars and body are made of specially hardened steel
- Alarm at a volume of at least 100 dB for 20 seconds, followed by automatic re-arming
- 3D position detection - detects vibrations and the smallest of movements in all three dimensions and triggers an alarm
- Smart alarm – the lock only emits a small warning beep in the event of minor and brief vibrations, e.g. if a football bounces nearby
- Acoustic signal indicates battery status and active status
- Bars are connected by special rivets
- ABUS XPlus cylinder for the greatest protection against manipulation, e.g. picking
- SH carrier included
- Transport position - do not insert the locking bar completely, so that the alarm is inactive
- Alarm position - insert locking bar completely; the alarm will be activated after locking
- Loudspeaker shielded behind locking bar

TECHNOLOGY



TEST SEALS



Ref. No.	EAN 4003318	cm	Weight g	Box Qty
6000KA/90 black SH	61500 9	90	1450	4
6000KA/120 black SH	62090 4	120	1700	4
Bracket SH 6000/90	61543 6		115	3
Bracket SH 6000/120	61564 1		132	3

BORDO™ 6000K

SECURITY LEVEL



FEATURES



XPlus™



Bracket SH 6000/90



Bracket SH SF 6000/90



Bracket SH 6000/120



VERSIONS



6000K/90 TwinSet



6000K/120



6000K/120 TwinSet

Folding locks

TECHNICAL DATA

- 5 mm bars with extra-soft yet resistant coating to prevent damage to paintwork
- The bars and the housing are made of specially hardened steel
- Bars are connected by special rivets
- ABUS XPlus cylinder for extremely high protection against manipulation, e.g. picking

TECHNOLOGY



TEST SEALS



Ref. No.	EAN 4003318	 cm	Weight g	Box Qty
6000K/90 black SH	62094 2	90	1330	4
6000K/90 black SH TwinSet	62095 9	90	1330 per locks	2
6000K/90 black SH SF	67865 3	90	1330	4
6000K/90 black SHFL	90973 3	90	1330	4
6000K/120 black SH	62091 1	120	1546	4
6000K/120 black SH TwinSet	67465 5	120	1546 per lock	2
Bracket SH 6000/90	61543 6		115	3
Bracket SH SF	67866 0		121	3
Bracket SH 6000/120	61564 1		132	3
Bracket SHFL 6000/90	88886 1		160	3

BORDO™ 6000C

NEW

SECURITY LEVEL



FEATURES



Bracket SH 6000/90



Bracket SH SF 6000/90



Bracket SHFL 6000/90

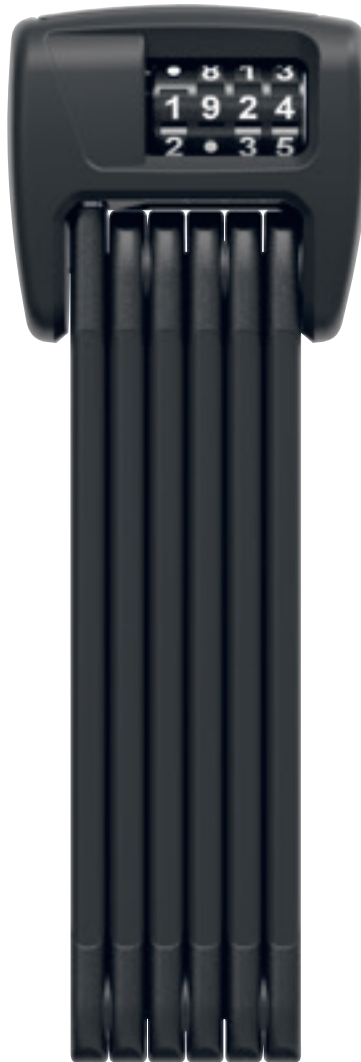

VERSIONS



6000C/120

TECHNICAL DATA

- 5 mm bars with extra-soft yet resistant coating to prevent damage to paintwork
- The bars and the housing are made of specially hardened steel
- Bars are connected by special rivets
- Two-component code dials ensures long-lasting legibility
- Opening code can be set individually
- Incl. SH holder

TECHNOLOGY



TEST SEALS



Ref. No.	EAN 4003318	 cm	Weight g	Box Qty
6000C/90 black SH	67599 7	90	1050	4
6000C/90 black SH SF	69069 3	90	1170	4
6000C/90 black SHFL	90972 6	90	1050	1
6000C/120 black SH	99926 0	120	1470	4
Bracket SH 6000/90	61543 6		115	3
Bracket SH SF	67866 0		121	3
Bracket SHFL 6000/90	88886 1		160	3

BORDO™ 6000C LED

SECURITY LEVEL



FEATURES



Combo Licht



Bracket SH 6000/90



Bracket SHFL 6000/90

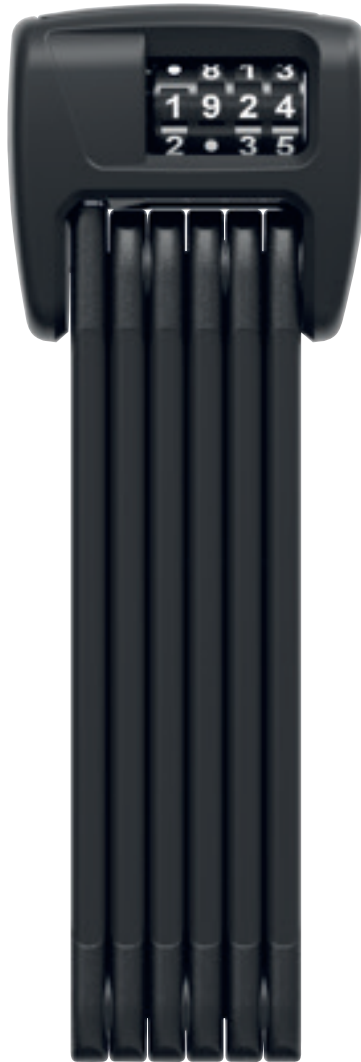

Folding locks

TECHNICAL DATA

- 5 mm thick bars, extra-soft coating to prevent damage to paintwork
- The bars and the housing are made of specially hardened steel
- Bars are connected by special rivets
- Integrated LED lamp for illuminating the code dials
- A CR1220 button battery to power the LED lamp is included
- Two-component code dials ensures long-lasting legibility
- Opening code can be set individually

TECHNOLOGY



TEST SEALS



Ref. No.

Ref. No.	EAN 4003318	 cm	Weight g	Box Qty
6000C/90 LED black SH	69057 0	90	1050	4
Bracket SH 6000/90	61543 6		115	3
Bracket SHFL 6000/90	88886 1		160	3

UGRIP BORDO™ 5700K

SECURITY LEVEL



FEATURES



Bracket SH 5700/80



Bracket SH 5700K/100



VERSIONS



5700K/100 lime



5700K/80 lime



5700K/100 blue



5700K/80 blue



5700K/100 red



5700K/80 red



5700K/100 black

TECHNICAL DATA

- 5 mm steel bars
- Colour-matching lock body
- Bars are linked with special rivets
- High-quality automatic cylinder
- The "convenient transport mode" (CTM) provides an immediate use of the lock (only 5700/100)

TECHNOLOGY



TEST SEALS



Ref. No.	EAN 4003318	 cm	Weight g	Box Qty
5700K/80 black SH	84425 6	80	960	6
5700K/80 lime SH	84427 0	80	960	6
5700K/80 blue SH	84426 3	80	960	6
5700K/80 red SH	84428 7	80	960	6
5700K/100 black SH	86743 9	100	1090	6
5700K/100 lime SH	86745 3	100	1090	6
5700K/100 blue SH	86744 6	100	1090	6
5700K/100 red SH	86746 0	100	1090	6
Bracket SH 5700/80	61566 5		122	3
Bracket SH 5700K/100	61571 9		122	3

UGRIP BORDO™ 5700 COMBO

SECURITY LEVEL



FEATURES



SH 5700/80

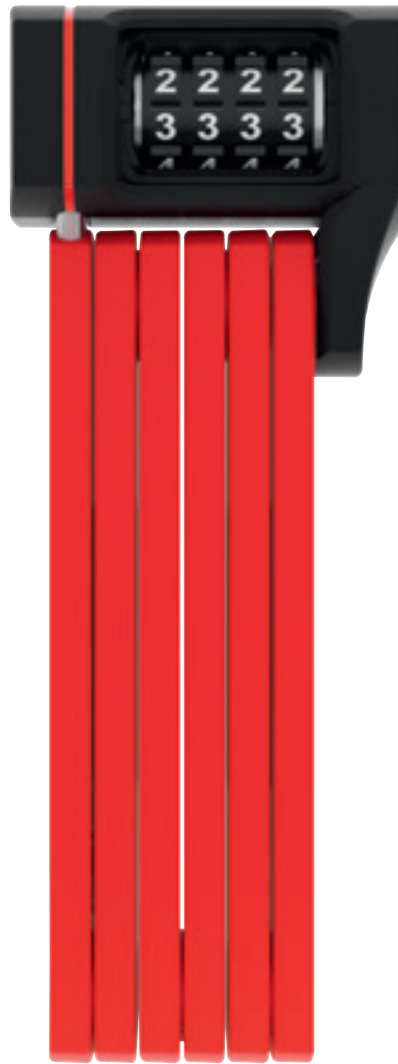

VERSIONS



5700C/80 black

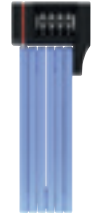

5700C/80 blue

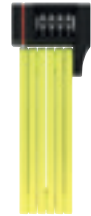

5700C/80 lime

Folding locks

TECHNICAL DATA

- 5 mm steel bars
- Bars are linked with special rivets
- Two component moulded digits guarantee life-long visibility
- Individually settable code

TECHNOLOGY



TEST SEALS



Ref. No.	EAN 4003318	 cm	Weight g	Box Qty
5700C/80 black SH	87791 9	80	960	6
5700C/80 blue SH	87792 6	80	960	6
5700C/80 lime SH	87793 3	80	960	6
5700C/80 red SH	87794 0	80	960	6
Bracket SH 5700/80	61566 5		122	3

BORDO™ LITE 6055K MINI

FEATURES



Bracket SH 6055



Bracket SR 6055



SECURITY LEVEL



VERSIONS



red



Movistar

TECHNICAL DATA

- Special steel construction with colour-coordinated plastic coating to protect against paint damage
- The bars and the housing are made of particularly light materials and steel alloys
- Connection of the bars by special rivets
- Optimal compromise between safety and weight
- Including holder (SH or SH Selle Royal)
- Ideal for the jersey pocket

TECHNOLOGY



TEST SEALS



Ref. No.

EAN
4003318



cm

Weight
g

Box
Qty

6055K/60 black

78060 8

60

400

6

6055K/60 black SH

62102 4

60

500

6

6055K/60 red

78061 5

60

400

6

6055K/60 Movistar TEAM

78062 2

60

400

6

BORDO™ LITE 6055K

FEATURES



Bracket SH 6055



Bracket SR 6055



SECURITY LEVEL



VERSIONS



red

TECHNICAL DATA

- Special steel design, with colour-coordinated plastic casing to prevent damage to paintwork
- The bars and housing are manufactured using particularly lightweight materials and steel alloys
- Bars connected with special rivets
- High-quality automatic cylinder
- The BORDO™ Lite Mini is small enough to slip into the pocket of any cycling jersey

TECHNOLOGY



TEST SEALS



Ref. No.

EAN
4003318



cm

Weight
g

Box
Qty

6055K/85 black SH

78063 9

85

550

6

6055K/85 black SR

62104 8

85

550

4

6055K/85 red SH

78064 6

85

550

6

Bracket SH 6055

61572 6

60

60

3

Bracket SR 6055 Selle Royal

63151 1

64

64

3

BORDO™ LITE 6055C MINI

FEATURES



Bracket SH 6055



Bracket SR 6055



TECHNICAL DATA

- Special steel design, with colour-coordinated plastic casing to prevent damage to paintwork
- The bars and housing are manufactured using particularly lightweight materials and steel alloys
- Bars connected with special rivets
- Two-component number reels guarantee long-term readability of the digits
- Individually configurable code
- Perfect security-weight ratio

SECURITY LEVEL

VERSIONS



red



blue Symbols



Movistar



pink Symbols

TECHNOLOGY



TEST SEALS



Ref. No.

EAN
4003318



cm

Weight
g

Box
Qty

6055C/60 black	62105 5	60	460	6
6055C/60 black SH	62110 9	60	550	6
6055C/60 red	62106 2	60	460	6
6055C/60 Movistar TEAM	62107 9	60	460	6
6055C/60 blue SYMBOLS	62109 3	60	460	6
6055C/60 pink SYMBOLS	62108 6	60	460	6

BORDO™ LITE 6055C

FEATURES



Bracket SH 6055



Bracket SR 6055



TECHNICAL DATA

- Special steel design, with colour-coordinated plastic casing to prevent damage to paintwork
- The bars and housing are manufactured using particularly lightweight materials and steel alloys
- Bars connected with special rivets
- Two-component number reels guarantee long-term readability of the digits
- Individually configurable code
- Perfect security-weight ratio
- Incl. bracket (SH or SR)

SECURITY LEVEL

VERSIONS



red

TECHNOLOGY



TEST SEALS



Ref. No.

EAN
4003318



cm

Weight
g

Box
Qty

6055C/85 black SH	62111 6	85	576	6
6055C/85 black SR	62113 0	85	604	4
6055C/85 red SH	62112 3	85	576	6
Bracket SH 6055	61572 6		60	3
Bracket SR 6055 Selle Royal	63151 1		64	3

CHAIN LOCKS



**GRANIT CITYCHAIN
XPLUS™ 1060**



black

Page 48

**IVY CHAIN
9210**



black

Page 49

**CITYCHAIN™
1010**



black

Page 50

**STEEL-O-CHAIN™
9809K**



black

Page 51

**STEEL-O-CHAIN™
9808K**



black

Page 51

**IVEN CHAIN
8210**



black

Page 52

8808C



black

Page 53



russet red

Page 53



jade green

Page 53

**IVERA CHAIN
7210**



black

Page 54

**IVERA CHAIN
7210 COLOR**



racing yellow

Page 55



desert tan

Page 55



diving blue

Page 55



metal blue

Page 55



sparkling orange

Page 55

**IVERA CHAIN
7210 COLOR**



bike packing

Page 55



anthracite

Page 55



crossing grey

Page 55

**YARDO
7807F**



black

Page 56

**STEEL-O-CHAIN™
8807K**



black

Page 58

**TRESOR
1385**



black

Page 59



aqua

Page 59



coral

Page 59



brown

Page 59

**TRESOR
1385 COLOR**



grey star Page 60 blue mask Page 60 grey lightning Page 60 cherry heart Page 60

**TRESOR
1385 NEON**



Neon blue Page 61 black Page 61 Neon green Page 61 Neon orange Page 61 Neon pink Page 61

**INFINITY LOOP
1806**



black Page 62 autumn orange Page 62 slow green Page 62

**CATENA
6806K**

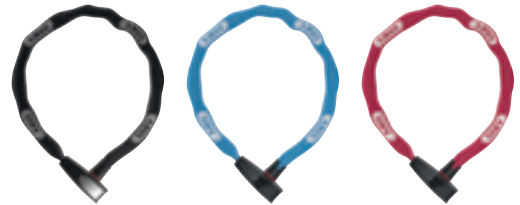

black Page 64 aqua Page 64 coral Page 64

**CATENA
6806K NEON**

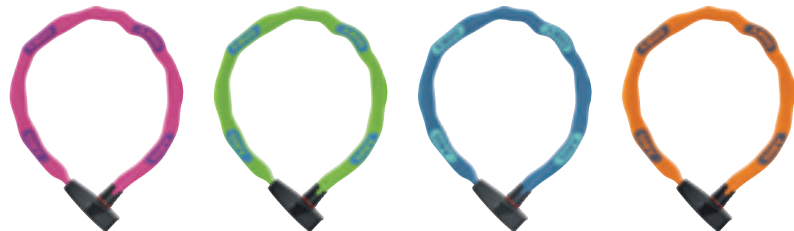

Neon pink Page 64 Neon green Page 64 Neon blue Page 64 Neon orange Page 64

**CATENA
6806K COLOR**



cherry heart Page 65 blue mask Page 65 grey lightning Page 65 grey star Page 65

**CATENA
6806K REFLECTIVE**



reflective Page 65

**STEEL-O-CHAIN™
5805K**

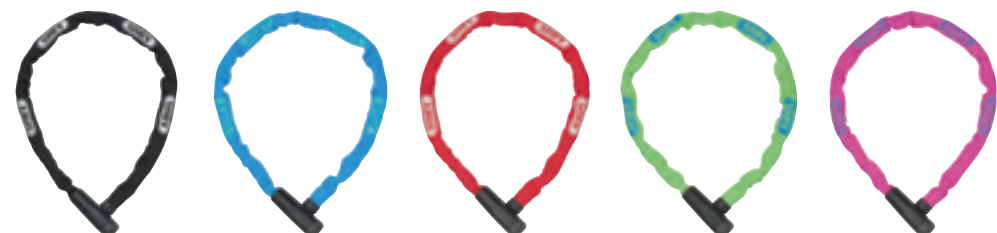

black Page 66 blue Page 66 red Page 66 lime Page 66 pink Page 66

**STEEL-O-CHAIN™
5805C**



black

Page 66



blue

Page 66



red

Page 66



lime

Page 66



pink

Page 66

**STEEL-O-CHAIN™
4804K**



black

Page 67



blue

Page 67



red

Page 67



lime

Page 67



pink

Page 67

**STEEL-O-CHAIN™
4804C SYMBOLS**



lime SYMBOLS

Page 68



blue SYMBOLS

Page 68



pink SYMBOLS

Page 68



red SYMBOLS

Page 68

**STEEL-O-CHAIN™
4804C**



black

Page 68



blue

Page 68



red

Page 68



lime

Page 68



pink

Page 68

1500 WEB



black

Page 69



lime

Page 69



orange

Page 69



coral

Page 69

1200 WEB



black

Page 69



lime

Page 69



orange

Page 69



red

Page 69



white

Page 69



coral

Page 69

GRANIT CITYCHAIN XPLUS™ 1060

SECURITY LEVEL



FEATURES



TECHNICAL DATA

- 10 mm hexagonal chain with textile sleeve to protect against damage to the paintwork
- ABUS Power Cell technology offers the highest level of protection against impacts and attempts to break the lock
- ABUS Power Link technology enables the chain to be connected directly to the Power Cell
- Interwoven coating of the lock body to protect against brutal methods of attack
- The chain, the lock body and supporting elements of the locking mechanism are made of specially hardened steel
- ABUS XPlus cylinder for the highest level of protection against tampering, e.g. picking
- Cover to protect the keyhole from contamination



TECHNOLOGY



TEST SEALS



1) Class C 2) VK 17218 3) Only for 1060/85 & 1060/110

Ref. No.	EAN 4003318	 mm	 cm	Weight g	Box Qty
1060/85 black	28678 0	10	85	2100	2
1060/110 black	28623 0	10	110	2650	2
1060/140 black	28624 7	10	140	3260	2
1060/170 black	28625 4	10	170	3750	2

IVY CHAIN 9210

SECURITY LEVEL



FEATURES



TECHNICAL DATA

- 10 mm square chain with new functional, durable and highly flexible synthetic fibre sleeve prevents damage to paintwork
- The chain, the lock body and supporting elements of the locking mechanism are made of specially hardened steel
- Ergonomically-shaped lock body
- Comes with a user-friendly reversible key

TECHNOLOGY



TEST SEALS



Ref. No.	EAN 4003318	⌀ mm	●—● cm	Weight g	Box Qty
9210/85 black	88691 1	10	85	2440	2
9210/110 black	88692 8	10	110	3000	2
9210/140 black	88693 5	10	140	3650	1
9210/170 black	88694 2	10	170	4400	1

CITYCHAIN™ 1010

SECURITY LEVEL



FEATURES



TECHNICAL DATA

- 9 mm hexagonal chain with fabric sleeve to prevent damage to the bicycle's paintwork
- The chain, the lock body and supporting elements of the locking mechanism are made of specially hardened steel
- ABUS Plus cylinder for high protection against manipulations, e.g. picking
- Automatic cover for the keyhole against dirt and corrosion

TECHNOLOGY



TEST SEALS



1) Class B

Ref. No.	EAN 4003318	⌀ mm	●—● cm	Weight g	Box Qty
1010/85 black	33559 4	9	85	1850	2
1010/110 black	12042 8	9	110	2200	2
1010/140 black	12527 0	9	140	2650	2
1010/170 black	12528 7	9	170	3200	2

STEEL-O-CHAIN™ 9809K

FEATURES





XPlus™



SECURITY LEVEL



Ref. No.

Ref. No.	EAN 4003318	 mm	 cm	Weight g	Box Qty
9809K/85 black	95548 8	9	85	2094	2
9809K/110 black	95549 5	9	110	2524	2
9809K/140 black	95550 1	9	140	3088	2
9809K/170 black	95551 8	9	170	3690	2

TECHNICAL DATA

- 9 mm thick square chain
- The chain, housing and structural parts of the locking mechanism are made of specially hardened steel
- Automatic keyhole cover to prevent corrosion and the ingress of dirt
- ABUS XPlus cylinder for the greatest protection against manipulation such as picking
- Two keys included

TECHNOLOGY



TEST SEALS



1) 35210

STEEL-O-CHAIN™ 9808K

FEATURES





XPlus™



SECURITY LEVEL



Ref. No.

Ref. No.	EAN 4003318	 mm	 cm	Weight g	Box Qty
9808K/85 black	95562 4	8	85	1782	2
9808K/110 black	95564 8	8	110	2102	2
9808K/140 black	95565 5	8	140	2596	2
9808K/170 black	95566 2	8	170	2988	2

TECHNICAL DATA

- 8 mm square chain
- The chain, housing and structural parts of the locking mechanism are made of specially hardened steel
- Automatic keyhole cover to prevent corrosion and the ingress of dirt
- ABUS XPlus cylinder for the greatest protection against manipulation such as picking
- Two keys included

TECHNOLOGY



TEST SEALS



1) Class B 2) 33324

IVEN CHAIN 8210

SECURITY LEVEL



FEATURES



TECHNICAL DATA

- 8 mm square chain with a functional, durable and highly flexible IvyTex synthetic fibre sleeve prevents damage to paintwork
- The chain, the lock body and supporting elements of the locking mechanism are made of specially hardened steel



TECHNOLOGY



TEST SEALS



1) VK 24192

Ref. No.	EAN 4003318	 mm	 cm	Weight g	Box Qty
8210/85 black	55152 9	8	85	1800	2
8210/110 black	55153 6	8	110	2200	2
8210/140 black	88288 3	8	140	2660	2

8808C

SECURITY LEVEL



VERSIONS



russet red



jade green





Chain locks

TECHNICAL DATA

- 8 mm chain with fabric sleeve to prevent damage to the bicycle's paintwork
- The chain is made of specially hardened steel
- Two-component number reels guarantee long-term readability of the digits
- Individually configurable code

TECHNOLOGY



Ref. No.	EAN 4003318	 mm	 cm	Weight g	Box Qty
8808C/85 black	61490 3	8	85	1990	2
8808C/85 russet red	61491 0	8	85	1990	2
8808C/85 jade green	61492 7	8	85	1990	2
8808C/110 black	61494 1	8	110	2370	2

IVERA CHAIN 7210

SECURITY LEVEL



FEATURES



Bracket IVERA RBU



TECHNICAL DATA

- 7 mm square chain with a functional, durable and highly flexible IvyTex synthetic fibre sheath prevents damage to paintwork
- The chain, the lock body and supporting elements of the locking mechanism are made of specially hardened steel

TECHNOLOGY



Ref. No.	EAN 4003318	⌀ mm	●○○ cm	Weight g	Box Qty
7210/85	55141 3	7	85	1300	2
7210/110	55142 0	7	110	1500	2
Bracket IVERA RBU	58497 8			125	1

IVERA CHAIN 7210 COLOR

NEW

SECURITY LEVEL



FEATURES



Bracket IVERA RBU



VERSIONS



sparkling orange



bike packing



metal blue



anthracite



diving blue



crossing grey



desert tan

TECHNICAL DATA

- 7 mm square chain with functional, long-life and highly-flexible mesh sleeve to prevent damage to the bicycle's paintwork
- The sleeve offers very high protection against abrasion and does not absorb any liquids e.g. water or oil
- The chain, the case as well as supporting elements of the locking mechanism are made of specially hardened steel

TECHNOLOGY



Ref. No.	EAN 4003318	⌀ mm	●—● cm	Weight g	Box Qty
7210/85 sparkling orange	87777 3	7	85	1300	2
7210/85 racing yellow	87778 0	7	85	1300	2
7210/85 metal blue	99556 9	7	85	1300	2
7210/85 diving blue	87779 7	7	85	1300	2
7210/85 desert tan	99553 8	7	85	1300	2
7210/85 crossing grey	87780 3	7	85	1300	2
7210/85 bike packing	99551 4	7	85	1300	2
7210/85 anthracite	99559 0	7	85	1300	2
7210/110 sparkling orange	87783 4	7	110	1500	2
7210/110 racing yellow	87782 7	7	110	1500	2
7210/110 metal blue	99555 2	7	110	1500	2
7210/110 diving blue	87784 1	7	110	1500	2
7210/110 desert tan	99554 5	7	110	1500	2
7210/110 crossing grey	87781 0	7	110	1500	2
7210/110 bike packing	99552 1	7	110	1500	2
7210/110 anthracite	99558 3	7	110	1500	2
Bracket IVERA RBU	58497 8			125	1

Chain locks

YARDO FINGERPRINT 7807F

SECURITY LEVEL



TECHNICAL DATA

- 7 mm thick round chain
- Lock body made of coated die-cast zinc
- CR2 battery included in the scope of delivery
- Precise capacitive fingerprint sensor
- Up to 20 individual fingerprints can be saved
- Double-bolted locking mechanism for improved protection against forced opening
- Quick locking without a key thanks to automatic locking
- Dustproof and weatherproof thanks to IP certification IP66 & IP68

TECHNOLOGY



Ref. No.	EAN 4003318	⌀ ↑ mm	●○○ cm	Weight g	Box Qty
7807F/85 BK	41001 7	7	85	1246	1
7807F/110 BK	40599 0	7	110	1480	1



STEEL-O-CHAIN™ 8807K

SECURITY LEVEL



FEATURES





TECHNICAL DATA

- 7 mm thick square chain with textile sleeve that prevents damage to paintwork
- The chain, the lock body and supporting elements of the locking mechanism are made of specially hardened steel

TECHNOLOGY



Ref. No.	EAN 4003318			Weight g	Box Qty
		mm	cm		
8807K/85 black	71195 4	7	85	1600	2
8807K/110 black	82519 4	7	110	1900	2

TRESOR 1385

SECURITY LEVEL



VERSIONS



aqua



coral



brown





Chain locks

TECHNICAL DATA

- 7 mm square chain with fabric sleeve to prevent damage to the bicycle's paintwork
- The chain is made of specially hardened steel
- Two component moulded digits guarantee life-long visibility
- Special touch protection for higher security against unauthorized access to the code through manipulation of the mechanism
- Individually settable code

TECHNOLOGY



Ref. No.	EAN 4003318	 mm	 cm	Weight g	Box Qty
1385/85 black	48566 4	7	85	1050	2
1385/85 aqua	48567 1	7	85	1050	2
1385/85 coral	48568 8	7	85	1050	2
1385/85 brown	48569 5	7	85	1050	2
1385/110 black	48628 9	7	110	1350	2

TRESOR 1385 COLOR

SECURITY LEVEL



VERSIONS



grey star



blue mask



grey lightning





TECHNICAL DATA

- 6 mm square chain with fabric sleeve to prevent damage to the bicycle's paintwork
- The chain is made of specially hardened steel
- Two component moulded digits guarantee life-long visibility
- Special touch protection for higher security against unauthorized access to the code through manipulation of the mechanism
- Individually settable code

TECHNOLOGY



Ref. No.	EAN 4003318	 mm	 cm	Weight g	Box Qty
1385/75 grey star	88010 0	6	75	750	6
1385/75 blue mask	88011 7	6	75	750	6
1385/75 grey lightning	88012 4	6	75	750	6
1385/75 cherry heart	88013 1	6	75	750	6

TRESOR 1385 NEON

SECURITY LEVEL



VERSIONS



black



neon green



neon orange



neon pink

Chain locks

TECHNICAL DATA

- 6 mm square chain with fabric sleeve to prevent damage to the bicycle's paintwork
- The chain is made of specially hardened steel
- Two component moulded digits guarantee life-long visibility
- Special touch protection for higher security against unauthorized access to the code through manipulation of the mechanism
- Individually settable code

TECHNOLOGY



Ref. No.	EAN 4003318	⌀ mm	●—● cm	Weight g	Box Qty
1385/75 black	51133 2	6	75	750	6
1385/75 neon green	71263 0	6	75	750	6
1385/75 neon blue	71262 3	6	75	750	6
1385/75 neon orange	71264 7	6	75	750	6
1385/75 neon pink	71265 4	6	75	750	6

INFINITY LOOP 1806

SECURITY LEVEL



FEATURES



VERSIONS



autumn orange



slow green

TECHNICAL DATA

- 6 mm thick square chain
- Loop ring diameter 60 mm
- Double-loop function: one loop secures components such as the front or rear wheel, the other secures the bike frame
- Durable and highly flexible IvyTex synthetic fibre coating protects the paintwork from abrasion or scratches
- Individually and infinitely adjustable length thanks to sliding lock body
- Quick locking without a key thanks to automatic locking: simply snap the bolt into the lock body
- Easy to transport

TECHNOLOGY



Ref. No.	EAN 4003318	⌀ mm	∞ cm	Weight g	Box Qty
1806/110 black	38114 0	6	110	1400	1
1806/140 black	38115 7	6	140	1600	1
1806/140 autumn orange	40999 8	6	140	1600	1
1806/140 slow green	40598 3	6	140	1600	1



CATENA 6806K

FEATURES



Bracket QST



SECURITY LEVEL



VERSIONS



aqua



coral

Ref. No.

EAN
4003318



mm



cm

Weight
g

Box
Qty

6806K/85 black	90169 0	6	85	920	6
6806K/85 aqua	90282 6	6	85	920	6
6806K/85 coral	90284 0	6	85	920	6
6806K/110 black	82511 8	6	110	1160	6
6806K/110 black QST	95479 5	6	110	1390	6
Bracket QST	61493 4			260	6

TECHNICAL DATA

- 6 mm thick square chain with textile sleeve that prevents damage to paintwork
- The chain is made of specially hardened steel

TECHNOLOGY



CATENA 6806K NEON

FEATURES



Bracket QST



SECURITY LEVEL



VERSIONS



neon green



neon blue



neon orange

Ref. No.

EAN
4003318



mm



cm

Weight
g

Box
Qty

6806K/85 neon green	90290 1	6	85	920	6
6806K/85 neon blue	90289 5	6	85	920	6
6806K/85 neon orange	90291 8	6	85	920	6
6806K/85 neon pink	90292 5	6	85	920	6
Bracket QST	61493 4			260	6

TECHNICAL DATA

- 6 mm square chain with textile sleeve to protect against damage to the paintwork
- The chain and the housing are made of specially hardened steel

TECHNOLOGY



CATENA 6806K COLOR

FEATURES



Bracket QST



SECURITY LEVEL



VERSIONS



blue mask



grey lightning



grey star

TECHNICAL DATA

- 6 mm square chain with fabric sleeve to prevent damage to the bicycle's paintwork
- The chain as well as case are made of specially hardened steel

TECHNOLOGY



Ref. No.

EAN
4003318



mm



cm

Weight
g

Box
Qty

6806K/85 cherry heart	90288 8	6	85	920	6
6806K/85 blue mask	90286 4	6	85	920	6
6806K/85 grey lightning	90287 1	6	85	920	6
6806K/85 grey star	90285 7	6	85	920	6
Bracket QST	61493 4			260	6

CATENA 6806K REFLECTIVE

FEATURES



Bracket QST



SECURITY LEVEL



TECHNICAL DATA

- 6 mm thick square chain with textile sleeve that prevents damage to paintwork
- The chain is made of specially hardened steel

TECHNOLOGY



Ref. No.

EAN
4003318



mm



cm

Weight
g

Box
Qty

6806K/85 reflective	69104 1	6	85	920	6
6806K/110 reflective	69105 8	6	110	1160	6
Bracket QST	61493 4			260	6

STEEL-O-CHAIN™ 5805K

FEATURES



TECHNICAL DATA

- 5 mm square chain with textile sleeve to protect against damage to the paintwork
- The chain is made of specially hardened steel

SECURITY LEVEL



VERSIONS



blue



red



lime



pink



TECHNOLOGY

Ref. No.

EAN
4003318

mm

cm

Weight
g

Box
Qty

Ref. No.	EAN 4003318	mm	cm	Weight g	Box Qty
5805K/75 black	71205 0	5	75	590	6
5805K/75 blue	72490 9	5	75	590	6
5805K/75 red	72489 3	5	75	590	6
5805K/75 lime	72491 6	5	75	590	6
5805K/75 pink	72492 3	5	75	590	6
5805K/110 black	72493 0	5	110	780	6

STEEL-O-CHAIN™ 5805C

SECURITY LEVEL



VERSIONS



blue



red



lime



pink



TECHNICAL DATA

- 5 mm thick square chain with textile sleeve that prevents damage to paintwork
- The chain is made of specially hardened steel
- Two-component number reels guarantee long-term readability of the digits
- The number code can be set individually

TECHNOLOGY

Ref. No.

EAN
4003318

mm

cm

Weight
g

Box
Qty

Ref. No.	EAN 4003318	mm	cm	Weight g	Box Qty
5805C/75 black	71206 7	5	75	500	6
5805C/75 blue	72494 7	5	75	500	6
5805C/75 red	72495 4	5	75	500	6
5805C/75 lime	72496 1	5	75	500	6
5805C/75 pink	72497 8	5	75	500	6
5805C/110 black	72498 5	5	110	720	6

STEEL- O- CHAIN™ 4804K

SECURITY LEVEL



FEATURES



VERSIONS



blue



red



lime



pink

Chain locks

TECHNICAL DATA

- 4 mm thick square chain with textile sleeve that prevents damage to paintwork
- The chain is made of specially hardened steel

TECHNOLOGY



Ref. No.	EAN 4003318			Weight g	Box Qty
		mm	cm		
4804K/75 black	72483 1	4	75	380	6
4804K/75 blue	72484 8	4	75	380	6
4804K/75 red	72485 5	4	75	380	6
4804K/75 lime	72486 2	4	75	380	6
4804K/75 pink	72487 9	4	75	380	6
4804K/110 black	72488 6	4	110	520	6

STEEL-O-CHAIN™ 4804C SYMBOLS



TECHNICAL DATA

- 4 mm square chain with fabric sleeve to prevent damage to the bicycle's paintwork
- The chain is made of specially hardened steel
- Playfully easy use for children due to symbols instead of digits
- Individually settable code

TECHNOLOGY



SECURITY LEVEL

VERSIONS



symbols blue



symbols pink



symbols red

Ref. No.

EAN
4003318



mm



cm

Weight
g

Box
Qty

4804C/75 blue SYMBOLS

86809 2

4

75

360

6

4804C/75 pink SYMBOLS

86810 8

4

75

360

6

4804C/75 red SYMBOLS

87499 4

4

75

360

6

4804C/75 lime SYMBOLS

87498 7

4

75

360

6

STEEL-O-CHAIN™ 4804C



TECHNICAL DATA

- 4 mm thick square chain with textile sleeve that prevents damage to paintwork
- The chain is made of special hardened steel
- Individually settable code

TECHNOLOGY



SECURITY LEVEL

VERSIONS



black



blue



red



lime



pink

Ref. No.

EAN
4003318



mm



cm

Weight
g

Box
Qty

4804C/75 black

71617 1

4

75

360

6

4804C/75 blue

71616 4

4

75

360

6

4804C/75 red

72468 8

4

75

360

6

4804C/75 lime

72480 0

4

75

360

6

4804C/75 pink

72481 7

4

75

360

6

4804C/110 black

72482 4

4

110

480

6

1500 WEB

FEATURES



TECHNICAL DATA

- 4 mm round chain with textile sleeve to protect against damage to the paintwork
- The chain is made of special steel

TECHNOLOGY



SECURITY LEVEL

VERSIONS



lime



orange



coral



red

Ref. No.

EAN
4003318

Color



mm



cm

Weight
g

Box
Qty

Ref. No.	EAN 4003318	Color	mm	cm	Weight g	Box Qty
1500/60 web black	56345 4		4	60	230	12
1500/60 web lime	56344 7		4	60	230	12
1500/60 web orange	56920 3		4	60	230	12
1500/60 web coral	57895 3		4	60	230	12
1500/60 web color	57658 4	lime, orange, red	4	60	230	12
1500/110 web black	56346 1		4	110	360	12
1500/110 web color	57659 1	lime, orange, red	4	110	360	12

1200 WEB

SECURITY LEVEL

VERSIONS



lime



orange



red



white



coral

Ref. No.

EAN
4003318

Color



mm



cm

Weight
g

Box
Qty

Ref. No.	EAN 4003318	Color	mm	cm	Weight g	Box Qty
1200/60 web black	56341 6		4	60	200	12
1200/60 web lime	56340 9		4	60	200	12
1200/60 web orange	56922 7		4	60	200	12
1200/60 web red	56339 3		4	60	200	12
1200/60 web white	56924 1		4	60	200	12
1200/60 web coral	57893 9		4	60	200	12
1200/60 web color	57656 0	lime, orange, red	4	60	200	12
1200/110 web black	56342 3		4	110	330	12
1200/110 web color	57657 7	lime, orange, red	4	110	330	12

TECHNICAL DATA

- 4 mm thick rounded chain with textile sleeve to prevent damage to paintwork
- The chain is made of special steel

GOOSE LOCK

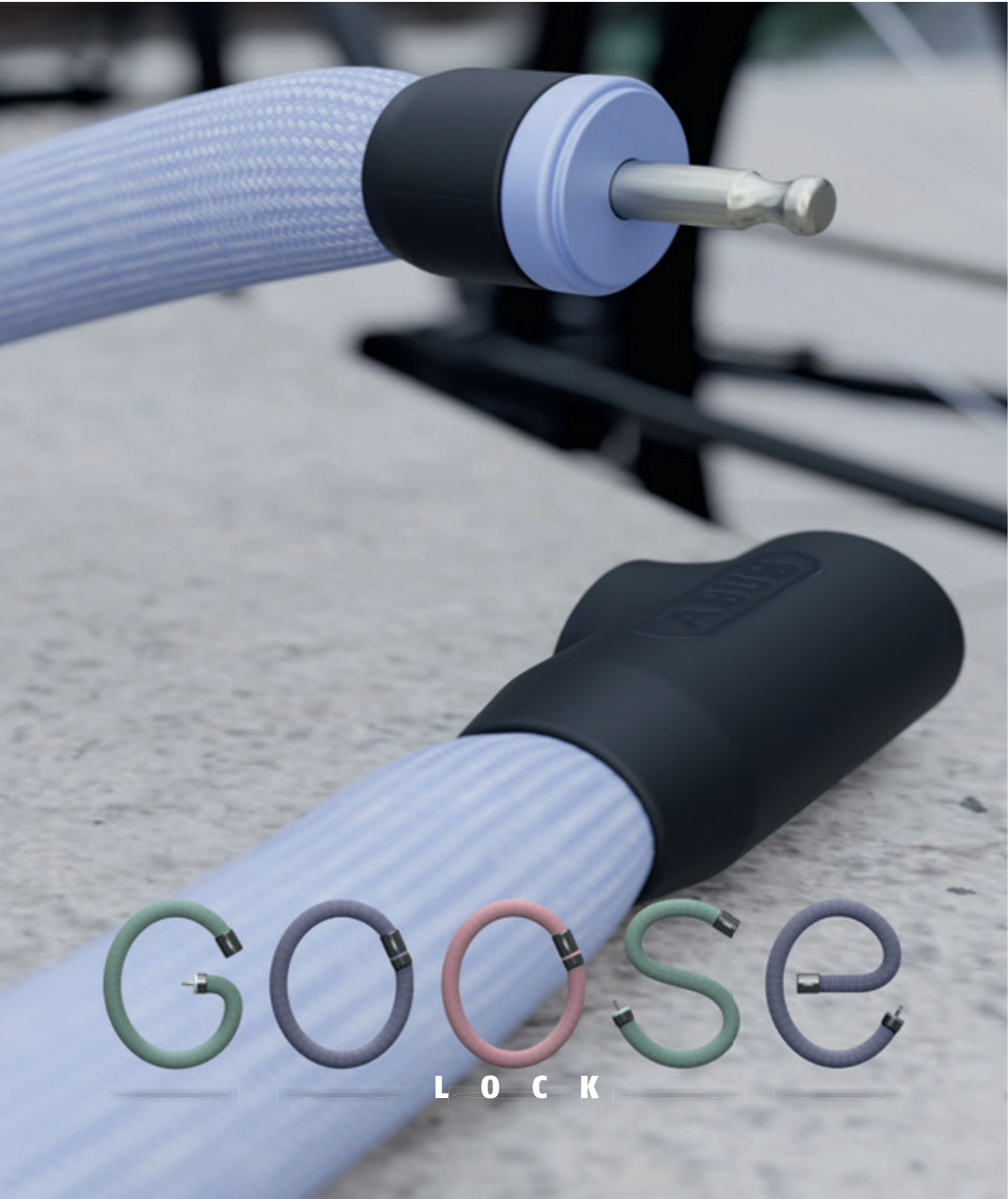

L O C K

GOOSE LOCK 6206K



mint

Page 72



black

Page 72



rosemauve

Page 72



flint

Page 72

GOOSE LOCK 4,204K



mint

Page 73



black

Page 73



rosemauve

Page 73



flint

Page 73

GOOSE LOCK 6206K

SECURITY LEVEL



FEATURES



VERSIONS



black



rosemauve





flint

TECHNICAL DATA

- 6 mm thick chain with functional, durable and highly flexible textile fibre sleeve
- Dimensionally stable and flexible chain lock with textile feel
- Soft coating provides strong protection against wear
- The chain, housing and structural parts of the locking mechanism are made of specially hardened steel

TECHNOLOGY



Ref. No.	EAN 4003318	 mm	 cm	Weight g	Box Qty
6206K/85 black	95546 4	6	85	920	6
6206K/110 black	95547 1	6	110	1120	6
6206K/110 rosemauve	96156 4	6	110	1120	6
6206K/110 mint	96158 8	6	110	1120	6
6206K/110 flint	96157 1	6	110	1120	6

GOOSE LOCK 4204K

SECURITY LEVEL



FEATURES



VERSIONS



rosemauve



mint



flint

TECHNICAL DATA

- 4 mm thick chain with functional, durable and highly flexible textile fibre sleeve
- Dimensionally stable and flexible chain lock with textile feel
- Soft fabric coating protects the paintwork and offers very high protection against abrasion
- The chain and the structural parts of the locking mechanism are made of specially hardened steel

TECHNOLOGY



Ref. No.	EAN 4003318	⌀ mm	●—● cm	Weight g	Box Qty
4204K/85 black	38138 6	4	85	710	6
4204K/110 black	38137 9	4	110	860	6
4204K/110 rosemauve	94401 7	4	110	860	6
4204K/110 mint	41022 2	4	110	860	6
4204K/110 flint	40674 4	4	110	860	6

Goose Lock

STEEL-O-FLEX LOCKS



STEEL-O-FLEX™

950



black

Page 76

IVEN STEEL-O-FLEX™

8200



black

Page 76

IVERA STEEL-O-FLEX™

7200



black

Page 77

CENTURO

860



black

Page 77

PHANTOM™

8960



black

Page 78

STEEL-O-FLEX™

RAYDO PRO 1460



black

Page 79

STEEL-O-FLEX™

TRESOR 1360



black

Page 80

MICROFLEX

6615K



black

Page 81

TRESORFLEX

6615C



black

Page 81

STEEL-O-FLEX™ 950

FEATURES



Plus



Bracket UGH 02

SECURITY LEVEL



TECHNICAL DATA

- Overlapping steel sleeves with a diameter of 25 mm protect the steel cable inside
- PVC casing to prevent damage to paintwork
- The steel sleeves and the structural parts of the locking mechanism are manufactured using specially hardened steel
- ABUS Plus cylinder for maximum protection against attempted manipulation, e.g. picking
- Two keys included in the scope of delivery
- Manual cover to protect the keyhole from dirt and corrosion
- ABUS Code Card for additional or replacement keys

TECHNOLOGY



TEST SEALS



Ref. No.	EAN 4003318			Weight g	Box Qty
		mm	cm		
950/100	25715 5	25	100	1540	2
Bracket UGH 02	26624 9			80	1

IVEN STEEL-O-FLEX™ 8200

FEATURES



Bracket UGH 02

SECURITY LEVEL



TECHNICAL DATA

- 25 mm thick, overlapping steel shells protect the internal steel cable
- The steel shells, the case as well as supporting elements of the locking mechanism are made of specially hardened steel
- Ergonomic lock body with softcase technology to prevent damage to the bicycle's paintwork
- New, functional, durable and highly flexible synthetic sleeve prevents damage to paintwork

TECHNOLOGY



TEST SEALS



Ref. No.	EAN 4003318			Weight g	Box Qty
		mm	cm		
8200/85	55148 2	25	85	1340	2
8200/110	55149 9	25	110	1580	2
Bracket UGH 02	26624 9			80	1

IVERA STEEL-O-FLEX™ 7200

FEATURES



Key Ivera



Ivera RBU Bracket



SECURITY LEVEL



Ref. No.

EAN
4003318



mm



cm

Weight
g

Box
Qty

7200/85

55137 6

22

85

700

6

7200/85 + RBU

55139 0

22

85

840

6

7200/110

55138 3

22

110

860

6

7200/110 + RBU

55140 6

22

110

1000

6

Bracket IVERA RBU

58497 8

125

1

TECHNICAL DATA

- 22 mm thick, overlapping steel shells protect the internal steel cable
- New, functional, durable and highly flexible synthetic sleeve prevents damage to paintwork
- The steel shells, the housing and the structural parts of the locking mechanism are manufactured using specially hardened steel

TECHNOLOGY



TEST SEAL



CENTURO 860

FEATURES



Bracket QuickSnap RBU



SECURITY LEVEL

VERSIONS



Ref. No.

EAN
4003318



mm



cm

Weight
g

Box
Qty

860/85

31495 7

20

85

780

6

860/110

31496 4

20

110

980

6

860/110 QS RBU

31494 0

20

110

1025

6

Bracket QuickSnap RBU

31487 2

40

6

TECHNICAL DATA

- 20 mm thick, overlapping steel shells protect the internal steel cable
- Plastic coating to prevent damage to the bicycle's paintwork
- The steel shells, the case as well as supporting elements of the locking mechanism are made of specially hardened steel

TECHNOLOGY



TEST SEAL



PHANTOM™ 8960

SECURITY LEVEL



FEATURES



Bracket TexFL



TECHNICAL DATA



- 17 mm thick, overlapping steel shells protect the internal steel cable
- Plastic coating to prevent damage to the bicycle's paintwork
- The shells, body and the structural parts of the locking mechanism are made of specially hardened steel
- ABUS Extra Classe (EC) automatic cylinder with coded reversible key

TECHNOLOGY



TEST SEALS



Ref. No.	EAN 4003318			Weight g	Box Qty
		mm	cm		
8960/110 TexFL	39683 0	17	110	920	6
Bracket TexFL	39730 1			77	1

STEEL-0-FLEX™ RAYDO PRO 1460

SECURITY LEVEL



FEATURES



Combo Light



Bracket TexKF Mini



TECHNICAL DATA

- 20 mm thick, overlapping steel shells protect the internal steel cable
- Plastic coating to prevent damage to the bicycle's paintwork
- The steel sleeves are manufactured using specially hardened steel
- Individually configurable code
- Press'n Shine function – LED-lit number reel for easy handling in the dark

TECHNOLOGY



TEST SEALS



Ref. No.

EAN
4003318



mm



cm

Weight
g

Box
Qty

1460/85 KF

59216 4

20

85

780

6

1460/85 TexKF

59217 1

20

85

780

6

Bracket TexKF Mini

23265 7

70

1

STEEL- O- FLEX™ TRESOR 1360

SECURITY LEVEL



TECHNICAL DATA

- 20 mm thick, overlapping steel shells protect the internal steel cable
- Plastic coating to prevent damage to the bicycle's paintwork
- Two-component number reels ensure long-term readability of the digits
- Special touch protection for increased security against unauthorised access to the code through manipulation of the mechanism
- Dark-touch function facilitates use in the dark thanks to special imprinting
- Individually configurable code

TECHNOLOGY



TEST SEALS



Ref. No.

EAN
4003318



Weight
g

Box
Qty

1360/85 black
1360/110 black

42935 4
42934 7

20
20

85
110

680
880

6
6

MICROFLEX 6615K

FEATURES



Bracket SCMU

Bracket SCLL



SECURITY LEVEL

VERSIONS





TECHNICAL DATA

- 15 mm thick, overlapping steel shells protect the internal steel cable
- Plastic coating to prevent damage to the bicycle's paintwork

TECHNOLOGY



Ref. No.	EAN 4003318	 mm	 cm	Weight g	Box Qty
6615K/85/15 black	13410 4	15	85	540	6
6615K/85/15 black SCMU	13408 1	15	85	580	6
6615K/85/15 black SCLL	86174 1	15	85	580	6
6615K/120/15 black	13412 8	15	120	700	6
6615K/120/15 black SCMU	13409 8	15	120	760	6
6615K/120/15 black SCLL	86172 7	15	120	760	6
Bracket SCLL 6K	87984 5			47	12
Bracket Snap Cage MU 6K	20079 3			40	12

TRESORFLEX 6615C

FEATURES



Bracket SCMU

Bracket SCLL



SECURITY LEVEL

VERSIONS





TECHNICAL DATA

- 15 mm thick, overlapping steel shells protect the internal steel cable
- Plastic coating to prevent damage to the bicycle's paintwork
- Two-component number reels ensure long-term readability of the digits
- Special touch protection for increased security against unauthorised access to the code through manipulation of the mechanism
- Dark-touch function facilitates use in the dark thanks to special imprinting
- Individually configurable code

TECHNOLOGY



Ref. No.	EAN 4003318	 mm	 cm	Weight g	Box Qty
6615C/85/15 black	13659 7	15	85	560	6
6615C/85/15 black SCMU	13657 3	15	85	705	6
6615C/85/15 black SCLL	86173 4	15	85	705	6
6615C/120/15 black	13780 8	15	120	720	6
6615C/120/15 black SCMU	13658 0	15	120	780	6
6615C/120/15 black SCLL	86171 0	15	120	780	6
Bracket SCLL 6C	87983 8			47	12
Bracket Snap Cage MU 6C	20113 4			40	12

COIL CABLE AND CABLE LOCKS



PHANTOM™

8950



black

Page 86

RAYDO PRO

1450



black

Page 87

BOOSTER

6512K



black

Page 88

TRESOR

6512C



black

Page 88

PRIMO

5510K



black

Page 89

NUMERO

5510C



black

Page 89

STAR

4508K



black

Page 90



blue

Page 90



red

Page 90



green

Page 90

STAR

4508C



black

Page 90



blue

Page 90



red

Page 90



green

Page 90

3506K



black

Page 91



blue

Page 91



orange

Page 91



red

Page 91



green

Page 91



pink

Page 91



silver

Page 91



3506C

black

Page 91

blue

Page 91

orange

Page 91

red

Page 91

green

Page 91

pink

Page 91



silver

Page 91



IVERA CABLE
7220

black

Page 93



RACER
6412K

black

Page 94



TRESOR
6412C

black

Page 94



PRIMO
5410K

black

Page 95



NUMERINO
5410C

black

Page 95



4408K

black

Page 96



blue

Page 96

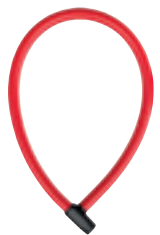

red

Page 96



green

Page 96



4408C

black

Page 96



blue

Page 96



red

Page 96



green

Page 96

3406K



black

Page 97



blue

Page 97



orange

Page 97



red

Page 97



green

Page 97



pink

Page 97



silver

Page 97

3406C



black

Page 97



blue

Page 97



orange

Page 97

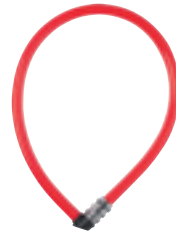

red

Page 97



green

Page 97



pink

Page 97



silver

Page 97

PHANTOM™ 8950

SECURITY LEVEL



FEATURES



Bracket KF



Bracket TexKF Mini



Bracket TexFL





TECHNICAL DATA

- 12 or 15 mm thick, high-quality and super flexible spiral cable
- Plastic coating in matte black look to prevent damage to the bicycle's paintwork
- ABUS Extra Classe (EC) automatic cylinder with coded reversible key

TECHNOLOGY



Ref. No.	EAN 4003318	 mm	 cm	Weight g	Box Qty
8950/180 KF	39685 4	12	180	645	6
8950/180 TexKF	39684 7	12	180	655	6
8950/180 TexFL	39802 5	12	180	665	6

RAYDO PRO 1450

SECURITY LEVEL



FEATURES



Combo light



Bracket TexKF Mini



TECHNICAL DATA

- 12 mm thick, high-quality and super flexible spiral cable
- Plastic coating to prevent damage to the bicycle's paintwork
- Individually configurable code
- Press'n Shine function – LED-lit number reel for easy handling in the dark

TECHNOLOGY



Coil cable and
cable locks

Ref. No.

EAN
4003318

mm

cm

Weight
g

Box
Qty

1450/185 black TexKF

59214 0

12

185

718

6

BOOSTER 6512K

FEATURES



Bracket SCMU



TECHNICAL DATA

- 12 mm thick, high-quality and super flexible spiral cable
- Plastic coating to prevent damage to the bicycle's paintwork

TECHNOLOGY



SECURITY LEVEL



Ref. No.

EAN
4003318



mm



cm

Weight
g

Box
Qty

6512K/180 black

13400 5

12

180

531

6

6512K/180 black SCMU

13399 2

12

180

573

6

Bracket SCMU 6K

20079 3

40

12

TRESOR 6512C

FEATURES



Bracket SCMU



TECHNICAL DATA

- 12 mm thick, high-quality and super flexible spiral cable
- Plastic coating to prevent damage to the bicycle's paintwork
- 2-component number reels guarantee long-term readability of the digits
- Individually configurable code

TECHNOLOGY



SECURITY LEVEL



Ref. No.

EAN
4003318



mm



cm

Weight
g

Box
Qty

6512C/180 black

13415 9

12

180

549

6

6512C/180 black SCMU

13414 2

12

180

600

6

Bracket SCMU 6C

20113 4

40

12

PRIMO 5510K

FEATURES



Bracket SCMU



TECHNICAL DATA

- 10 mm thick, high-quality and super flexible spiral cable
- Plastic coating to prevent damage to the bicycle's paintwork

TECHNOLOGY



SECURITY LEVEL



Ref. No.

EAN
4003318



mm



cm

Weight
g

Box
Qty

5510K/180 black

14260 4

10

180

460

6

5510K/180 black SCMU

14245 1

10

180

508

6

Bracket SCMU 4K/5K

20080 9

40

12

NUMERO 5510C

FEATURES



Bracket SCMU



TECHNICAL DATA

- 10 mm thick, high-quality and super flexible spiral cable
- Plastic coating to prevent damage to the bicycle's paintwork
- Dark-touch function facilitates use in the dark thanks to special imprinting
- Two-component number reels ensure long-term readability of the digits
- Individually configurable code

TECHNOLOGY



SECURITY LEVEL



Ref. No.

EAN
4003318



mm



cm

Weight
g

Box
Qty

5510C/180 black

16524 5

10

180

460

6

5510C/180 black SCMU

16523 8

10

180

508

6

Bracket SCMU 4C/5C

20111 0

40

12

STAR 4508K

FEATURES



TECHNICAL DATA

- 8 mm thick, high-quality and super flexible spiral cable
- Plastic coating to prevent damage to the bicycle's paintwork

TECHNOLOGY



SECURITY LEVEL

VERSIONS



blue



red



green

Ref. No.

EAN
4003318



mm



cm

Weight
g

Box
Qty

4508K/150 black

20016 8

8

150

280

12

4508K/150 blue

40775 8

8

150

280

12

4508K/150 red

40776 5

8

150

280

12

4508K/150 green

40777 2

8

150

280

12

STAR 4508C

SECURITY LEVEL

VERSIONS



blue



red



green

Ref. No.

EAN
4003318



mm



cm

Weight
g

Box
Qty

4508C/150 black

20019 9

8

150

260

12

4508C/150 blue

40778 9

8

150

260

12

4508C/150 red

40779 6

8

150

260

12

4508C/150 green

40780 2

8

150

260

12

TECHNICAL DATA

- 8 mm thick, high-quality and super flexible spiral cable
- Plastic coating to prevent damage to the bicycle's paintwork
- Dark-touch function facilitates use in the dark thanks to special imprinting
- Individually configurable code

TECHNOLOGY



3506K

FEATURES



TECHNICAL DATA

- 6 mm thick and super flexible spiral cable
- Plastic coating to prevent damage to the bicycle's paintwork

SECURITY LEVEL

VERSIONS



blue



orange



red



green



pink



silver

Ref. No.

EAN
4003318

Version



mm



cm

Weight
g

Box
Qty

3506K/120 black

40769 7

6

120

182

12

3506K/120 color

40770 3

2x all colors except
black

6

120

182

12

3506K/180 black

40771 0

6

180

182

12

3506C



TECHNICAL DATA

- 6 mm thick and super flexible spiral cable
- Plastic coating to prevent damage to the bicycle's paintwork

SECURITY LEVEL

VERSIONS



blue



orange



red



green



pink



silver

Ref. No.

EAN
4003318

Version



mm



cm

Weight
g

Box
Qty

3506C/120 black

40772 7

6

120

174

12

3506C/120 color

40773 4

2x all colors except
black

6

120

174

12



IVERA CABLE 7220

SECURITY LEVEL



FEATURES



Bracket IVERA RBU



TECHNICAL DATA



- 20 mm thick, high-quality steel cable
- New, functional, durable and highly flexible Ivy synthetic-fibre coating to prevent damage to the paintwork
- The body and structural parts of the locking mechanism are manufactured using specially hardened steel

TECHNOLOGY



TEST SEALS



Ref. No.	EAN 4003318	 mm	 cm	Weight g	Box Qty
7220/85 black	55145 1	20	85	660	6
Bracket IVERA RBU	58497 8			125	1

Coil cable and
cable locks

RACER 6412K

FEATURES



Bracket SCMU



TECHNICAL DATA

- 12 mm thick steel cable
- Plastic coating to prevent damage to the bicycle's paintwork

TECHNOLOGY



SECURITY LEVEL

VERSIONS



Ref. No.

EAN
4003318



mm



cm

Weight
g

Box
Qty

6412K/85 black

40804 5

12

85

386

6

6412K/85 black SCMU

40805 2

12

85

387

6

6412K/120 black

63491 8

12

120

492

6

Bracket SCMU 6K

20079 3

40

12

TRESOR 6412C

FEATURES



Bracket SCMU



TECHNICAL DATA

- 12 mm thick steel cable
- Plastic coating to prevent damage to the bicycle's paintwork
- Two component moulded digits guarantee life-long visibility
- Individually configurable code

TECHNOLOGY



SECURITY LEVEL

VERSIONS



Ref. No.

EAN
4003318



mm



cm

Weight
g

Box
Qty

6412C/85 black

40807 6

12

85

396

6

6412C/85 black SCMU

40808 3

12

85

441

6

6412C/120 black

63489 5

12

120

503

6

Bracket SCMU 6C

20113 4

40

12

PRIMO 5410K

FEATURES



Bracket SCMU



TECHNICAL DATA

- 10 mm thick steel cable
- Plastic coating to prevent damage to the bicycle's paintwork

TECHNOLOGY



SECURITY LEVEL



Ref. No.

EAN
4003318



mm



cm

Weight
g

Box
Qty

5410K/85 black

40798 7

10

85

278

6

5410K/85 black SCMU

40799 4

10

85

330

6

Bracket SCMU 4K/5K

20080 9

40

12

NUMERINO 5410C



TECHNICAL DATA

- 10 mm thick steel cable
- Plastic coating to prevent damage to the bicycle's paintwork
- Two component moulded digits guarantee life-long visibility
- Individually configurable code

TECHNOLOGY



SECURITY LEVEL



Ref. No.

EAN
4003318



mm



cm

Weight
g

Box
Qty

5410C/85 black

40801 4

10

85

276

6

4408K

FEATURES



TECHNICAL DATA

- 8 mm thick steel cable
- Plastic coating to prevent damage to the bicycle's paintwork

SECURITY LEVEL

VERSIONS



blue



red



green

Ref. No.

EAN
4003318



mm



cm

Weight
g

Box
Qty

4408K/65 black

40790 1

8

65

271

12

4408K/65 blue

40791 8

8

65

271

12

4408K/65 red

40792 5

8

65

271

12

4408K/65 green

40793 2

8

65

271

12

4408C

TECHNICAL DATA

- 8 mm thick steel cable
- Plastic coating to prevent damage to the bicycle's paintwork

TECHNOLOGY



SECURITY LEVEL

VERSIONS



blue



red



green

Ref. No.

EAN
4003318



mm



cm

Weight
g

Box
Qty

4408C/65 black

40794 9

8

65

271

12

4408C/65 blue

40795 6

8

65

271

12

4408C/65 red

40796 3

8

65

271

12

4408C/65 green

40797 0

8

65

271

12

3406K

FEATURES



TECHNICAL DATA

- 6 mm thick steel cable
- Plastic coating to prevent damage to the bicycle's paintwork

SECURITY LEVEL

VERSIONS



blue



orange



red



green



pink



silver

Ref. No.

EAN
4003318

Version



mm



cm

Weight
g

Box
Qty

3406K/55 black

40782 6

6

55

139

12

3406K/55 color

40785 7

2x all colors except black

6

55

139

12

3406C

TECHNICAL DATA

- 6 mm thick steel cable
- Plastic coating to prevent damage to the bicycle's paintwork



SECURITY LEVEL

VERSIONS



blue



orange



red



green



pink



silver

Ref. No.

EAN
4003318

Version



mm



cm

Weight
g

Box
Qty

3406C/55 black

40787 1

6

55

114

12

3406C/55 color

40789 5

2x all colors except black

6

55

114

12

FRAME LOCKS AND BATTERY LOCKS



GRANIT XPLUS™

6950



black

Page 94

PRO AMPARO

4750X / XL



black

Page 96

PRO AMPARO

4750S / SL



black

Page 97

AMPARO

4650X / XL



black

Page 98

AMPARO

4650S / SL



black

Page 98

PRO TECTIC™

4960



black

Page 99

TECTIC™

496



black

Page 99

ACH 2.0

ADAPTOR CHAIN



black

Page 100

ADAPTOR

CABLE



black

Page 100

IVYTEX

ADAPTOR CHAIN



black

Page 101



crossing grey

Page 101

FRAME LOCKS

We want to help you find the right frame lock for your customer's bike even faster in the future. The dimensions below should help you with this.

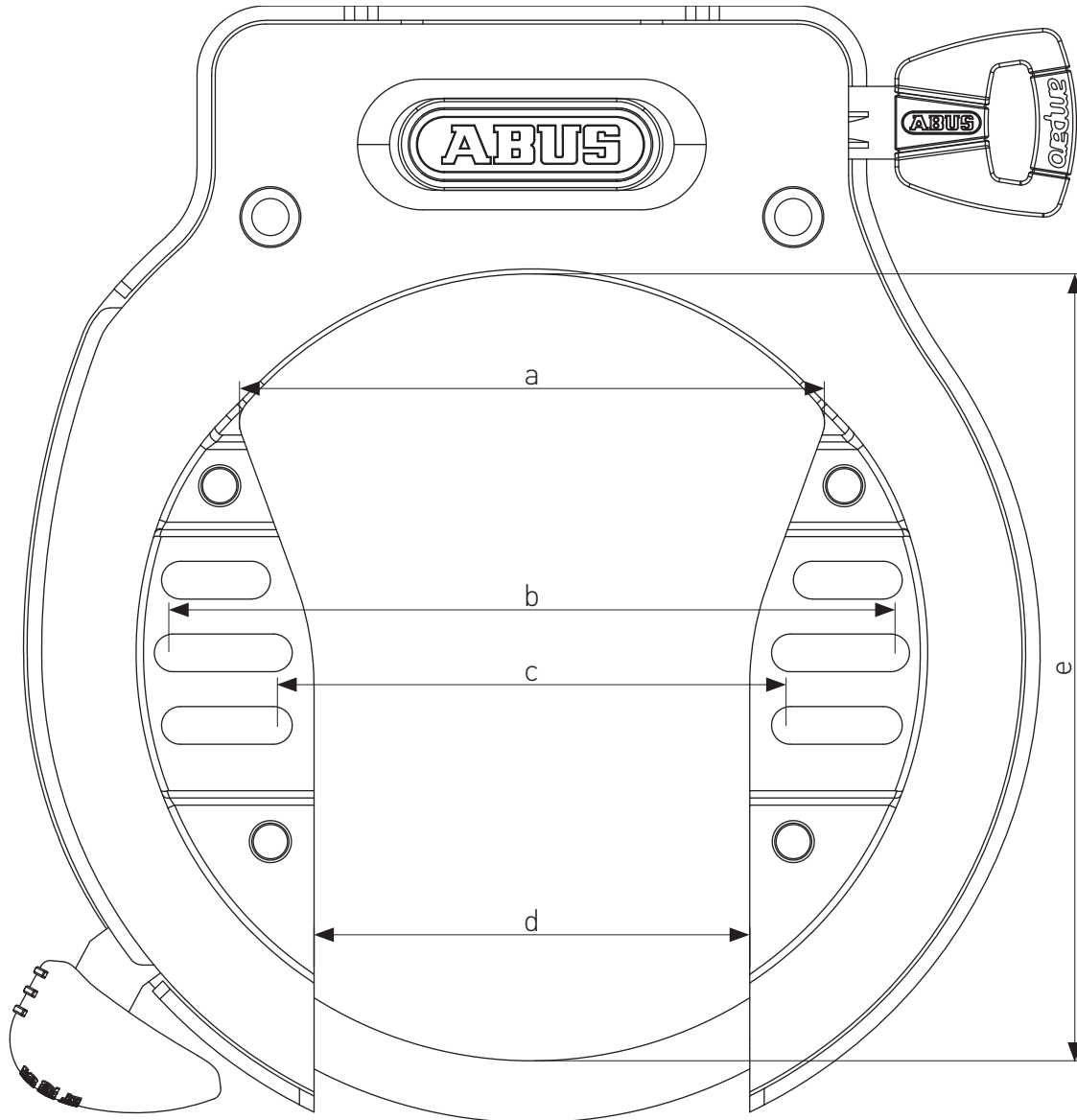

- a Maximum mudguard width
- b Maximum hole spacing of rear mounting points
- c Minimum hole spacing of rear mounting points
- d Maximum tire width
- e Maximum height clearance (top of mudguard vs rim)

You will find an overview of all dimensions on the next page. In addition, you will also find all relevant dimensions on each product page in the tables.

Ref. No.	EAN	a	b	c	d	e	Weight	Box
	4003318	mm	mm	mm	mm	mm	g	Qty

ALL FRAME LOCK DIMENSIONS IN OVERVIEW

6950M AM

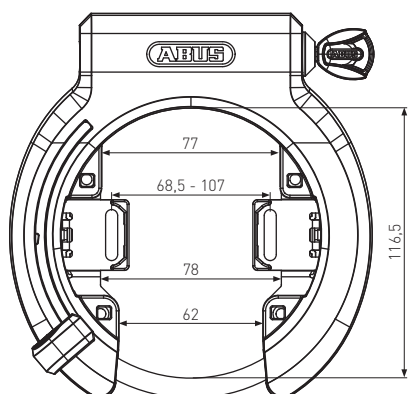

4750X / 4750XL

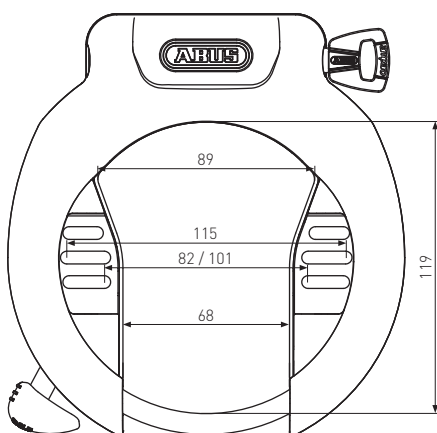

4750S / 4750SL

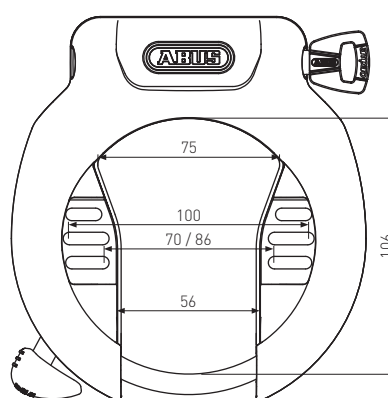

4650X / 4650XL

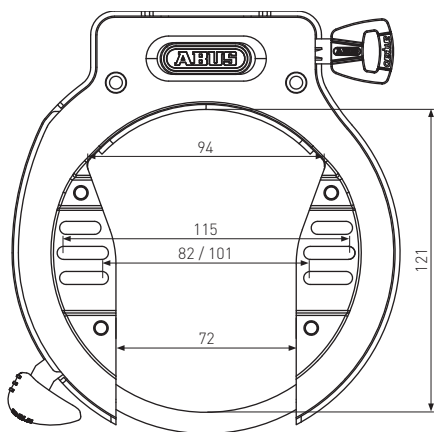

4650S / 4650SL

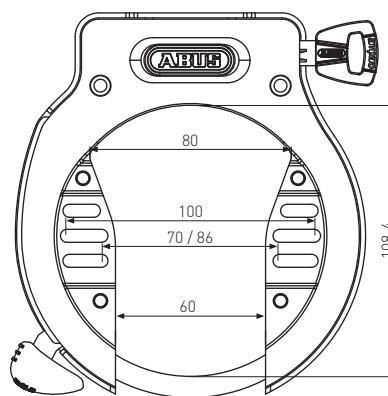

4960

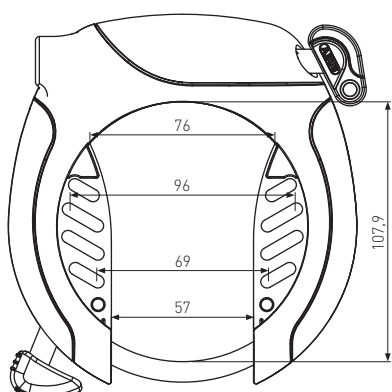

496

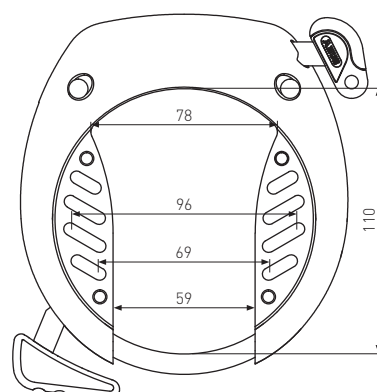

Frame locks and
battery locks

All dimensions in mm.

GRANIT XPLUS™ 6950

SECURITY LEVEL



FEATURES



XPlus™



All Mounting Plate



FMU 6950



Adapter plate 6950



TECHNICAL DATA

- 8.5 mm thick locking shackle
- The shackle, housing and structural parts of the locking mechanism are made of specially hardened steel
- Closing mechanism for simple connection of accessories in the lock housing
- ABUS XPlus cylinder for the greatest protection against manipulation such as picking
- In the R variant, the key remains in the cylinder when the lock is opened; in the NR variant, it can be removed
- Hole spacing for mounting is universally adjustable

TECHNOLOGY



TEST SEALS



1) VK 38581 2) only for R-variants.

Ref. No.	EAN 4003318	a mm	b mm	c mm	d mm	e mm	Weight g	Box Qty
6950M AM R BK XPlus™	61914 4	77	68,5-107	78	62	116,5	770	6
6950M AM R BK XPlus™ OE	61928 1	77	68,5-107	78	62	116,5	770	10
6950M AM NR BK XPlus™	61915 1	77	68,5-107	78	62	116,5	770	6
6950M AM NR BK XPlus™ OE	61916 8	77	68,5-107	78	62	116,5	770	10
6950M AM NR BK XPlus™ + 6KS/85 + ST 5950	95912 7	77	68,5-107	78	62	116,5	1560	3
6950M AM NR BK XPlus™ + 6KS/100 + ST 5950	95913 4	77	68,5-107	78	62	116,5	1750	3
6950M AM NR BK XPlus™ + 6KS/130 + ST 5950	61924 3	77	68,5-107	78	62	116,5	1920	3
FMU 6950 2 pieces	96201 1						40	1
Adapter plate 6950 10 pieces	99186 8						40	10



Security Tech Germany

6950M AM GRANIT XPLUS™

THE LOCK WITH UNIVERSAL FRAME FITTING

Thanks to the moveable mounting slots one lock
will fit all common frame and tyre sizes

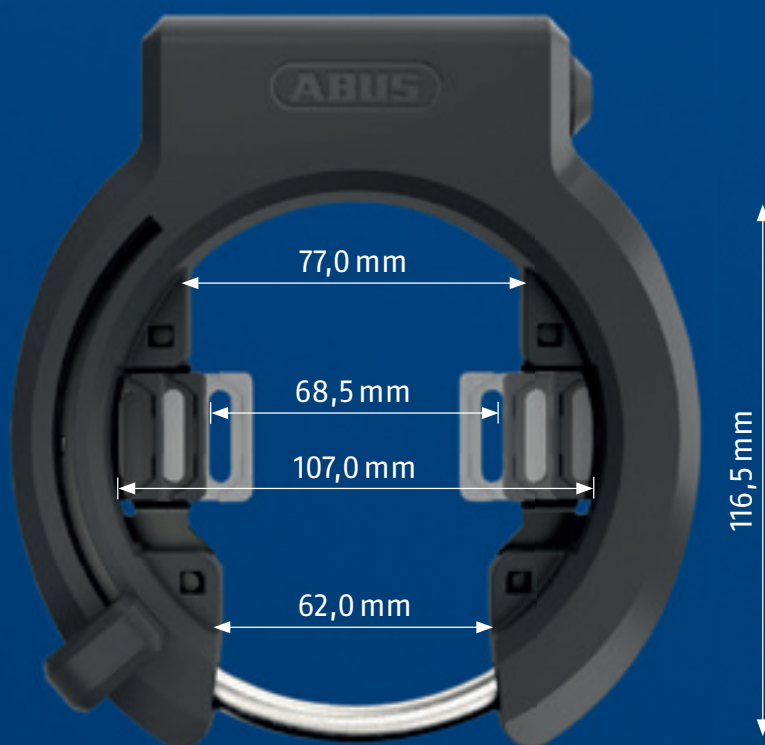

Made in Germany

PRO AMPARO 4750 X / XL

SECURITY LEVEL



FEATURES



SH



Mounting straps LH



VERSIONS



4750XL

TECHNICAL DATA

- 8.5 mm steel shackle
- The case, the shackle as well as supporting elements of the locking mechanism are made of specially hardened steel
- Extreme large aperture for extra wide tires
- Closing mechanism for easy attachment of accessory to the lock body
- In the R variant, the key remains in the cylinder when the lock is opened; in the NR variant, it can be removed

TECHNOLOGY



TEST SEALS



1) VK 35482 2) Applies only to R variants.

Ref. No.	EAN	a	b	c	d	e	Weight	Box
	4003318	mm	mm	mm	mm	mm	g	Qty
4750X NR black PRO AMPARO	69349 6	89	115	82	68	119	860	12
4750X NR black OE	86734 7	89	115	82	68	119	860	12
4750X R black PRO AMPARO	69352 6	89	115	82	68	119	860	12
4750X R black OE	86735 4	89	115	82	68	119	860	12
4750XL NR black PRO AMPARO	69353 3	89	115	101	68	119	800	12
4750XL NR black OE	86736 1	89	115	101	68	119	800	12
4750XL R black PRO AMPARO	69354 0	89	115	101	68	119	800	12
4750XL R black OE	86737 8	89	115	101	68	119	800	12
SH485/495	37552 1						56	6
Mounting strap LH adaptor	56240 2						48	1

PRO AMPARO 4750 S / SL

SECURITY LEVEL



FEATURES



SH



Mounting straps LH



VERSIONS



4750SL

TECHNICAL DATA

- 8.5 mm shackle
- The shackle, the housing and the locking mechanism's load-bearing parts are manufactured from specially hardened steel
- Accessories can easily be fitted to the locking mechanism on the lock housing
- In the R version, the key remains in the cylinder when the lock is opened; in the NR version, it can be removed

TECHNOLOGY



TEST SEALS



1) VK 34358 2) Applies only to R variants.

Ref. No.	EAN	a	b	c	d	e	Weight	Box
	4003318	mm	mm	mm	mm	mm	g	Qty
4750S NR black PRO AMPARO	89676 7	75	100	70	56	106	652	1
4750S NR black OE	82611 5	75	100	70	56	106	700	16
4750S R black PRO AMPARO	89677 4	75	100	70	56	106	700	12
4750S R black OE	82612 2	75	100	70	56	106	760	16
4750SL NR black PRO AMPARO	89678 1	75	100	86	56	106	740	1
4750SL NR black OE	83573 5	75	100	86	56	106	740	16
4750SL R black PRO AMPARO	89679 8	75	100	86	56	106	740	12
4750SL R black OE	83574 2	75	100	86	56	106	740	16
SH485/495	37552 1						56	6
Mounting strap LH adaptor	56240 2						48	1

Frame locks and battery locks

AMPARO 4650 X / XL

FEATURES



SH



Mounting straps LH



SECURITY LEVEL

VERSIONS



4650XL

TECHNICAL DATA

- 8.5 mm steel shackle
- The case, the shackle as well as supporting elements of the locking mechanism are made of specially hardened steel
- Extreme large aperture for extra wide tires
- Closing mechanism for easy attachment of accessory to the lock body
- In the R version, the key remains in the cylinder when the lock is opened; in the NR version, it can be removed

TECHNOLOGY



TEST SEALS



Ref. No.	EAN	a	b	c	d	e	Weight	Box Qty
	4003318	mm	mm	mm	mm	mm	g	
4650X NR black OE	86730 9	94	115	82	72	121	720	14
4650X R black OE	86731 6	94	115	82	72	121	720	14
4650XL NR black OE	86732 3	94	115	101	72	121	720	14
4650XL R black OE	86733 0	94	115	101	72	121	720	14
4650X NR BK T82 + ACH 2.0 6KS/100 + ST 590	96992 8	94	115	82	72	121	2125	4
SH485/495	37552 1						56	6
Mounting strap LH adaptor	56240 2						48	1

AMPARO 4650 S / SL

FEATURES



SH



Mounting straps LH



SECURITY LEVEL

VERSIONS



4650SL

TECHNICAL DATA

- 8.5 mm shackle
- The shackle, the housing and the locking mechanism's load-bearing parts are manufactured from specially hardened steel
- Accessories can easily be fitted to the locking mechanism on the lock housing
- In the R version, the key remains in the cylinder when the lock is opened; in the NR version, it can be removed

TECHNOLOGY



TEST SEALS



Ref. No.	EAN	a	b	c	d	e	Weight	Box Qty
	4003318	mm	mm	mm	mm	mm	g	
4650S NR black OE	82609 2	80	100	70	60	108,4	660	20
4650S R black OE	82610 8	80	100	70	60	108,4	660	20
4650SL NR black OE	83575 9	80	100	86	60	108,4	640	20
4650SL R black OE	83576 6	80	100	86	60	108,4	640	20
SH485/495	37552 1						56	6
Mounting strap LH adaptor	56240 2						48	1

PRO TECTIC™ 4960

FEATURES



SH



SECURITY LEVEL



VERSIONS



4960 + 6KS/85 + ST5850

TECHNICAL DATA

- 8.5 mm thick locking shackle
- The shackle, the case as well as supporting elements of the locking mechanism are made of specially hardened steel
- Accessories can easily be fitted to the locking mechanism on the lock housing
- In the R version, the key remains in the cylinder when the lock is opened; in the NR version, it can be removed

TECHNOLOGY



Ref. No.	EAN	a mm	b mm	c mm	d mm	e mm	Weight g	Box Qty
4960 NR black	11260 7	76	96	69	57	107,9	520	6
4960 NR black OE	11270 6	76	96	69	57	107,9	520	18
4960 NR black + 6KS/85 + ST5850	11263 8	76	96	69	57	107,9	1346	4
SH485/495	37552 1						56	6
Mounting strap LH adaptor	56240 2						48	1

TECTIC™ 496

FEATURES



SH

Mounting straps LH



TECHNICAL DATA

- 8.5 mm thick locking shackle
- The shackle, the case as well as supporting elements of the locking mechanism are made of specially hardened steel
- In the R version, the key remains in the cylinder when the lock is opened; in the NR version, it can be removed

TECHNOLOGY



SECURITY LEVEL



Ref. No.	EAN	a mm	b mm	c mm	d mm	e mm	Weight g	Box Qty
496 NR black	11258 4	78	96	69	59	110	450	6
496 NR black OE	11269 0	78	96	69	59	110	450	24
496 R black OE	19457 3	78	96	69	59	110	450	24
SH485/495	37552 1						56	6
Mounting strap LH adaptor	56240 2						48	1

ACH 2.0 ADAPTOR CHAIN

FEATURES



ST5950



ST5050





ST5850



TECHNICAL DATA

- 6 and 8 mm square chain made of hardened steel
- Separate locking of the shackle is not necessary
- Various connection options
- Suitable for all ABUS frame locks and the Alarmbox 2.0
- Special coating on the loop ring protects the bike's paintwork from being damaged

Ref. No.	EAN 4003318	 mm	 cm	Weight g	Box Qty
ACH 2.0 6KS/85 black	95369 9	6	85	760	6
ACH 2.0 6KS/85 black + ST5950	95371 2	6	85	840	6
ACH 2.0 6KS/100 black	95360 6	6	100	860	6
ACH 2.0 6KS/100 black + ST5950	95363 7	6	100	1130	6
ACH 2.0 6KS/130 black	95366 8	6	130	1140	6
ACH 2.0 6KS/130 black + ST5950	38101 0	6	130	1220	6
ACH 2.0 8KS/85 black	95375 0	8	85	1190	6
ACH 2.0 8KS/85 black + ST5950	95376 7	8	85	1270	6
ACH 2.0 8KS/100 black	95373 6	8	100	1400	1
Tasche ST 5850/5650/4960	48647 0			100	1
ST 5050	40992 9				60
ST 5950 2.0	87510 6				1

ACL ADAPTOR CABLE

FEATURES





ST5850



TECHNICAL DATA

- 12 mm thick, high-quality steel cable
- Opens up a lot of opportunities for locking the bicycle on to a fixed object

Ref. No.	EAN 4003318	 mm	 cm	Weight g	Box Qty
ACL 12/100 black	18243 3	12	100	416	6
ST 5850/5650/4960	48647 0			100	1

IVYTEX ADAPTOR CHAIN



FEATURES



ST5950



ST5050

VERSIONS



crossing grey

TECHNICAL DATA

- Adapter chain with IvyTex coating
- Square profile chain made of our own hardened steel alloy
- Durable cover made of synthetic IvyTex fibre offers resistance to saw attacks
- Hydrophobic IvyTex cover repels dirt and moisture
- 6 and 8 mm square chain made of hardened steel
- Fabric coating on the loop ring to protect against damage to the paintwork
- With frame locks, there is no need to separately lock the shackle
- Various options for connecting to fixed objects or linking multiple bicycles
- Suitable for ABUS frame locks and Alarmbox 2.0

TECHNOLOGY



Ref. No.	EAN	 mm	 cm	Weight g	Box Qty
4003318	68457 9	6	85	760	6
ACH IVY 6KS/85 crossing grey	68456 2	6	85	760	6
ACH IVY 6KS/100 black	68460 9	6	100	860	6
ACH IVY 6KS/100 black + ST5950	69055 6	6	100	1064	6
ACH IVY 6KS/100 crossing grey	68459 3	6	100	860	6
ACH IVY 6KS/130 black	68463 0	6	130	1140	6
ACH IVY 6KS/130 crossing grey	68462 3	6	130	1140	6
ACH IVY 8KS/100 black	68466 1	8	100	1400	4
ACH IVY 8KS/100 crossing grey	68465 4	8	100	1400	4
ST 5050	40992 9				60
ST 5950 2.0	87510 6				1

SERVICE PRICELIST

BATTERY LOCKS

Bafang		Cube	
96306	BLO BAF 15,7 T82 Service	96677	BLO CUB IT1.B3 XPLUS Service
Bike Fun		96679	BLO CUB IT2 XPLUS Service
96514	BLO BFI IT1 T82 Service	96678	BLO CUB IT2.B3 XPLUS Service
Bosch		Cycle Union	
96515	BLO BOS AX1 T82 Service	96682	BLO CYU IT1 XPLUS Service
96303	BLO BOS IT2.1 T82 Service	Darfon	
96521	BLO BOS DT2 PLUS Service	96300	BLO DAF UNI LC T83 Service
96281	BLO BOS DT2 T82 Service	96513	BLO DAF UNI T82 Service
96675	BLO BOS DT2 XPLUS Service	96692	BLO DAF UNI T83 Service
96516	BLO BOS DT3 T82 Service	Fazua	
96517	BLO BOS DT3 T82 XL Service	96574	BLO FAZ IT1 PLUS Service
96671	BLO BOS DT3 T83 Service	96690	BLO FAZ IT2 XPLUS Service
96673	BLO BOS IT2.1 XPLUS Service		
96301	BLO BOS IT3 T82 Service		
96672	BLO BOS IT3 T83 Service		
96563	BLO BOS RT2 PLUS Service		
96297	BLO BOS UNI T82 Service		
99392	BLO+BRA WIN IT1 XPLUS Service		
99393	BLO BOS IT4 XPLUS Service		
40455	BLO BOS DT3.1 XPLUS Service		
94353	BLO BOS DT3.1 T82 Service		
40974	BLO BOS DT3.1 XL XPLUS Service		

Fit Bketec

96681 BLO FIT IT1 XPLUS Service

Giant

96504 BLO GIA IT1 F T82 Service

96948 BLO GIA IT1 M T82 Service

96952 BLO GIA IT1 M XPLUS Service

Panasonic

96299 BLO PAN DT1 T82 Service

96570 BLO PAN IT1 PLUS Service

96674 BLO PAN IT1 XPLUS Service

Pexco

96577 BLO PEX IT2 PLUS Service

96565 BLO PEX IT3 PLUS Service

98414 BLO PEX IT3 XPLUS Service

Phyllion

96307 BLO PHY 11,3 T82 Service

Scott

96680 BLO SCO IT2 auf IT2.1 Service

Shimano

96572 BLO SHI DT1 PLUS Service

96575 BLO SHI IT2 PLUS Service

96507 BLO SHI IT2 T82 ASY Service

96289 BLO SHI RT1 T82 Service

Specialized

96573 BLO SPE IT2 PLUS Service

96670 BLO SPE IT3 T83 Service

96683 BLO SPE IT3 XPLUS Service

Trek

96509 BLO TRE IT1 T82 Service

96984 BLO TRE IT1 PLUS Service

ZEG

96491 BLO ZEG IT1 T82 Service

96571 BLO ZEG IT3 PLUS Service

96576 BLO ZEG IT5 PLUS Service

96990 BLO ZEG IT4 XPLUS Service

98420 BLO ZEG IT5 XPLUS Service

Winora

96566 BLO+BRA WIN IT1 PLUS Service

96567 BLO WIN IT2 PLUS Service

IT: Intube

DT: Downtube

RT: Racktube

* These products will be delivered
without individual packaging

SPECIAL SECURITY



CHAIN CLAW 10



black

Page 116

ALARMBOX 2.0



black

Page 117

ALARMBOX RC



black

Page 117

WCH90



black

Page 118

GRANIT™ WBA 100



black

Page 119

GRANIT™ WBA 75



black

Page 119

WBA 65



black

Page 120

WBA 60



black

Page 121

WA 50



black

Page 121

SPORTFLEX 2504



black

Page 122

COMBIFLEX™



black

Page 122



neon

Page 122



midnight blue

Page 122



black + CHR

Page 122

COMBIFLEX™ TRAVELGUARD



black

Page 123



yellow

Page 123



red

Page 123

COMBIFLEX™ ADVENTURE



black

Page 123

COMBILLOOP 205



black

Page 124

CHAIN 6 KS LOOP



black

Page 124

COBRA™



black

Page 125

1850



black

Page 125

**FIRESTOP
AFS625**



Page 126

PS 88



Page 126

**KEYGARAGE™
SMART 797**



Page 127

**KEYGARAGE™
SMART 787**



Page 127

**KEYGARAGE™
787 BIG LED**



Page 128

**KEYGARAGE™
787 BIG**



Page 128

**KEYGARAGE™
787 LED**



Page 129

**KEYGARAGE™
787**



Page 129

**KEYGARAGE™
797 LED**



Page 130

**KEYGARAGE™
797**



Page 130

**KEYGARAGE™
767**



Page 131

ABUS TOUCH™ 57



silber

Page 131

145



black

Page 132

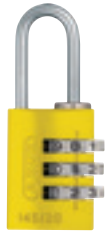

yellow

Page 132



orange

Page 132



red

Page 132



violet

Page 132



blue

Page 132

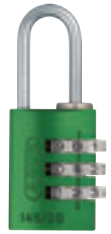

green

Page 132



silver

Page 132



titan

Page 132

64 TITALIUM™



Page 133

70 & 70IB



70

Page 134



70IB

Page 134

DISKUS®

24IB



Page 134

DISKUS®

20



Page 135

147TSA



Page 135

CHAIN CLAW 10

SECURITY LEVEL



TECHNICAL DATA

- 7 mm thick and 10 cm long square chain
- Rotating joints and a 55mm diameter engagement point for the cuffs provide maximum flexibility
- The chain as well as parts of the housing and clamps are made of specially hardened steel
- Opening code can be set individually

TECHNOLOGY



Ref. No.	EAN 4003318	 mm	 cm	Weight g	Box Qty
Chain Claw 10 black	95934 9	7	10	1070	1

ALARMBOX 2.0



VERSIONS



Alarmbox 2.0 black + ACH 6KS/100 Alarmbox 2.0 black + ACL 12/100

TECHNICAL DATA

- Alarm function with min. 100 dB for 15 seconds, followed by reactivation
- 3D Position Detection - alarm system that detects vibrations and the smallest movements in all three dimensions and triggers the alarm
- Smart alarm – the Alarmbox only emits a small warning beep in the event of minor and brief vibrations, e.g. if a football bounces nearby
- CR2 batteries included
- Mounting option on almost all round geometries
- Connection option for ABUS adapter chains and cables

TECHNOLOGY



Ref. No.	EAN	Weight g	Box Qty
Alarmbox 2.0 black	4003318	430	12
Alarmbox 2.0 black + ACH 6KS/100	61482 8	1270	6
Alarmbox 2.0 black + ACL 12/100	61488 0	720	6

ALARMBOX RC

VERSIONS



RC



TECHNICAL DATA

- Alarmbox with remote control
- Alarm function with min. 100 dB for 15 seconds, followed by reactivation
- 3D position detection - detects vibrations and the smallest of movements in all three dimensions and triggers an alarm
- Smart alarm – the Alarmbox only emits a small warning beep in the event of minor and brief vibrations, e.g. if a football bounces nearby
- Convenient arming and disarming by remote control
- CR2 battery included (Alarmbox) / CR2032 battery included (remote control)
- Mounting option on almost all round geometries
- Very lightweight and therefore ideal for use in sports and outdoors
- Various connection options such as cable ties, double-sided adhesive tape, Velcro, etc.

TECHNOLOGY



Ref. No.	EAN	Weight g	Box Qty
Alarmbox RC SingleSet black	4003318	82	12
Alarmbox RC Box only	61487 3	70	12
RC Remote Control Alarmbox black	69059 4	16	12

WCH90

SECURITY LEVEL



FEATURES



VERSIONS



WCH90 + ACH 9KS/130



WCH90 + ACH 9KS/130

TECHNICAL DATA

- Wall anchor with integrated chain
- Hardened steel housing for high attack resistance
- The wall anchor is firmly anchored in the wall with special high security plugs and thus offers an extremely high level of theft protection
- The mounting plugs are included in the scope of delivery
- Only suitable for wall mounting
- The chain and the housing are made of specially hardened steel
- Textile coating to protect against paint damage
- The chains are available in different lengths
- ABUS XPlus cylinder for the greatest protection against manipulation, such as picking

TECHNOLOGY



TEST SEALS



Ref. No.	EAN 4003318	⊕ ↑	●○○	Weight g	Box Qty
WCH90 + ACH 9KS/110	69061 7	9	110	3580	3
WCH90 + ACH 9KS/110 Twin Chain	69063 1	9	110	6620	2
WCH90 + ACH 9KS/130	69062 4	9	130	3960	3

WBA100 GRANIT™

FEATURES



SECURITY LEVEL



Security level
motorbike



TECHNICAL DATA

- 16 mm thick shackle made of hardened special steel for maximum attack resistance
- Incl. mounting accessories

TEST SEALS



Ref. No.

EAN
4003318



mm



mm



mm



mm



mm

Weight
g

1880

Box
Qty

1

WBA100 GRANIT™

27161 8

160

165

16

65

77

1880

1

WBA75 GRANIT™

FEATURES



SECURITY LEVEL



TECHNICAL DATA

- 14 mm thick shackle made of hardened special steel for maximum resistance
- Incl. mounting accessories

TEST SEALS



Ref. No.

EAN
4003318



mm



mm



mm



mm



mm

Weight
g

850

Box
Qty

1

WBA75 GRANIT™

78606 8

135

98

14

57

65

850

1

WBA65

FEATURES



TECHNICAL DATA

- 10 mm thick shackle made of hardened special steel for maximum attack resistance
- Holder for the rear wheel
- Simple installation without dowels

SECURITY LEVEL



TEST SEALS



Ref. No.

EAN
4003318



mm



mm



mm



mm



mm

Weight
g

Box
Qty

WBA65 B/SB + Bike Holder

97167 9

118

80

mm

mm

mm

1094

10



WBA60

FEATURES



TECHNICAL DATA

- 10 mm thick shackle made of hardened special steel for maximum attack resistance
- Incl. mounting accessories

SECURITY LEVEL



TEST SEALS



Ref. No.

EAN
4003318



mm



mm



mm



mm



mm

Weight
g

Box
Qty

WBA60

82211 7

118

80

10

52

55

450

1

WA50

FEATURES



TECHNICAL DATA

- Strong wall anchor made of hardened steel
- Incl. mounting material

SECURITY LEVEL



Ref. No.

EAN
4003318



mm



mm



mm



mm



mm

Weight
g

Box
Qty

WA50

04294 2

80

110

38

38

786

1

SPORTFLEX 2504



TECHNICAL DATA

- Very lightweight and space-saving cable lock for mounting under the bottle holder
- Mounting by means of two screws included in the scope of delivery at the attachment points on the frame tube of the bicycle
- Low profile of 20 mm enables mounting under an existing bottle holder
- Self-retracting cable
- Opening code can be set individually
- Ideal for protection against opportunistic theft

TECHNOLOGY



Ref. No.	EAN 4003318	 mm	 cm	Weight g	Box Qty
2504/90	69054 9	2,4	90	100	1

COMBIFLEX™



TECHNICAL DATA

- Self-retracting cable
- Opening code can be set and changed by the user
- Attractive pocket format fits comfortably in any pocket
- Extendible steel cable

TECHNOLOGY



VERSIONS





neon



midnight blue



black + CHR

Ref. No.	EAN 4003318	 mm	 cm	Weight g	Box Qty
Combiflex™ StopOver 65 black	95454 2	1,2	65	46	12
Combiflex™ StopOver 65 neon	95458 0	1,2	65	46	12
Combiflex™ StopOver 65 midnight blue	95459 7	1,2	65	46	12
Combiflex™ Break 85 black	95455 9	1,5	85	58	12
Combiflex™ Break 85 neon	95460 3	1,5	85	58	12
Combiflex™ Break 85 midnight blue	95461 0	1,5	85	58	12
Combiflex™ Rest 105 black	95456 6	2,4	105	85	12
Combiflex™ Rest 105 black + CHR	95484 9	2,4	105	96	12
Combiflex™ Trip 125 black	95457 3	3	125	128	12

COMBIFLEX™ TRAVELGUARD



TECHNICAL DATA

- Cable protection with extra solid steel core
- Users can set and change the 3-digit code themselves
- Cable lock with releasable locking mechanism
- Small and lightweight, fits well in trouser or jersey pocket

TECHNOLOGY





VERSIONS



black



yellow

Ref. No.	EAN 4003318	 mm	 cm	Weight g	Box Qty
TravelGuard black	95468 9	4	45	80	32
TravelGuard yellow	95601 0	4	45	80	32
TravelGuard red	95600 3	4	45	80	32

COMBIFLEX™ ADVENTURE



TECHNICAL DATA

- Compact cable lock with retractable cable
- Users can set and change the 3-digit code themselves
- Attractive pocket format fits comfortably in any pocket
- 4 mm thick and 75 cm long steel cable

TECHNOLOGY



Ref. No.	EAN 4003318	 mm	 cm	Weight g	Box Qty
Combiflex™ Adventure black	95465 8	4	75	90	1

COMBILoop 205





TECHNICAL DATA

- 5 mm thick steel cable
- Synthetic coating to prevent damage to the bicycle's paintwork
- Automatic locking at insertion of the locking bolt
- Individually settable code

SECURITY LEVEL



TECHNOLOGY



Ref. No.	EAN 4003318	 mm	 cm	Weight g	Box Qty
205/200 black	52523 0	5	200	180	12

6KS LOOP



TECHNICAL DATA

- 6 mm-thick square chain made of hardened steel
- Diameter of loop rings: 30 mm and 50 mm
- A textile sleeve around the chain and a plastic coating on the 50 mm ring protect against paint damage
- Available in two lengths: 100 cm and 140 cm

Ref. No.	EAN 4003318	 mm	 cm	Weight g	Box Qty
6KS100 Loop	97023 8	6	100	860	6
6KS140 Loop	97024 5	6	140	1220	1





TECHNICAL DATA

- High quality steel cable with two loop ends
- Synthetic coating to prevent damage to the bicycle's paintwork

VERSIONS



Ref. No.	EAN 4003318	 mm	 cm	Weight g	Box Qty
Cobra™ 5/75 black	37106 6	5	75	75	100
Cobra™ 8/200 black	25718 6	8	200	280	1
Cobra™ 8/250 black	27390 2	8	250	395	16
Cobra™ 10/140 black	37107 3	10	140	310	30
Cobra™ 10/200 black	11167 9	10	200	400	1
Cobra™ 10/220 black	37108 0	10	220	420	24
Cobra™ 10/300 black	59930 9	10	300	560	21
Cobra™ 10/500 black	20780 8	10	500	850	1
Cobra™ 10/1000 black	20781 5	10	1000	1580	1
Cobra™ 12/120 black	25719 3	12	120	380	1
Cobra™ 12/180 black	27391 9	12	180	490	15

1850



TECHNICAL DATA

- High quality steel cable with two loop ends
- Synthetic coating to prevent damage to the bicycle's paintwork

Ref. No.	EAN 4003318	 mm	 cm	Weight g	Box Qty
1850/185	12752 6	8	185	280	18

FIRE STOP AFS625



TECHNICAL DATA

- 625 ml highly effective foam extinguishing agent
- Easy to use – just like a conventional spray can
- Spraying range (max. distance between source of fire and user) up to 4 m
- Spray time approx. 25 seconds
- Weight: approx. 900 g gross
- Shelf life: 39 months
- Suitable for fighting incipient fires of fire classes A, B and F
- Fire class 5A: solid and non-melting substances
- Fire class 21B: liquid and melting substances
- Fire class 15F: cooking fats and cooking oils
- Also for use with electrical systems of up to 1000 V (distance of at least 1 m)

ACCESSORIES



Bracket AFS625/FLS580

Ref. No.

Ref. No.	EAN 4003318	Weight	Box Qty
AFS625	85727 0	847	6
Bracket AFS625/FLS580	56249 5	81	1

PS88



TECHNICAL DATA

- Free from chlorine, fluorine (CKW/FCKW), PCB, lead and other contaminants
- Non-greasy special lubricant spray
- Door cylinders, bicycle lock cylinders, padlock cylinders, car locks, tools, sports equipment, office machines



Ref. No.

Ref. No.	EAN 4003318	Weight g	Box Qty	Version
PS88 50ml D	00117 8	59	1	50 ml aerosol can
PS88 125ml D	07010 5	124	1	125 ml aerosol can
PS88 300ml D	84408 9	301	1	300 ml aerosol can
VK PS88 50ml D	08217 7	60	1	24 x 50 ml
VK PS88 125ml D	06952 9	124	1	12 x 125 ml
VK PS88 300ml D	84409 6	3900	1	12 x 300 ml

797 KEYGARAGE™ ONE



TECHNOLOGY



TECHNICAL DATA

- Sturdy metal housing provides secure storage space for keys and valuables
- Up to 20 keys, up to 3 car keys or 30 plastic cards fit in the key box compartment
- There are 2 hooks for hanging keys or key rings
- Smart operation and management of the KEYGARAGE with the free HomeTec Pro Bluetooth or ABUS One apps
- Overview of key box use in the app's clear event log
- Automatic locking after the compartment is closed
- Illuminated keypad for convenient input of the numeric code in the dark
- LED for status indication (unlocked, locked, incorrect PIN and low battery)
- Battery compartment for 2 x AA batteries, accessible from the outside
- For secure storage of keys or small valuable objects for authorised persons
- Quick and easy access for frequently changing groups of people (e.g. tradespeople, service staff, holiday guests, vehicle hire customers, care service)
- Share access via an individual six-digit numeric code or by invitation to a smart-phone
- Mounting with shackle for flexible and temporary use indoors or in protected outdoor areas (e.g. on door knobs, railings or handles)
- Storage of whole key rings possible thanks to the large internal compartment
- Real-time remote access to all functions such as unlocking, locking, viewing event logs and managing access permissions via the separately available BRIDGE One.

Ref. No.

Ref. No.	EAN 4003318	 mm	 mm	 mm	Weight g	Box Qty
797 KEYGARAGE™ One with shackle	63825 1	82,5	63	179	888	18

787 KEYGARAGE™ ONE





TECHNOLOGIE



TECHNICAL DATA

- Secure storage of keys and small valuables in a sturdy metal housing
- Up to 20 keys, up to 3 car keys or 30 plastic cards fit in the key box compartment
- There are 2 hooks for hanging keys or key rings
- Smart operation and management of the KEYGARAGE with the free HomeTec Pro Bluetooth or ABUS One apps
- Overview of key box use in the app's clear event log
- Automatic locking after the compartment is closed
- Illuminated keypad for optimal input of the numerical code in the dark
- LED for status indication (unlocked, locked, incorrect PIN and low battery)
- Battery compartment for 2 x AA batteries, accessible from the outside
- For secure storage of keys or small valuable objects for authorised persons
- Quick and easy access for frequently changing groups of people (e.g. tradespeople, service staff, holiday guests, vehicle hire customers, care service)
- Share access via an individual 6-digit numeric code or by invitation to a smartphone
- For wall mounting indoors and in protected outdoor areas
- Storage of whole key rings possible thanks to the large internal compartment
- Real-time remote access to all functions such as unlocking, locking, viewing event logs and managing access permissions via the separately available BRIDGE One.

Ref. No.

Ref. No.	EAN 4003318	 mm	 mm	 mm	Weight g	Box Qty
787 KEYGARAGE™ One wall mounting	63824 4	82,5	63	120	883	18

787 BIG LED KEYGARAGE™



TECHNOLOGY



TECHNICAL DATA

- Solid metal housing
- Locking cover made of zinc die-cast
- 4-digit individually settable code
- Illuminated dials for a better legibility in dark conditions
- LEDs light up ca. 30 seconds
- Coin cell battery (CR2032) can be easily replaced, durability of battery when used 1x per day approximately 2 years
- Protective cover with sliding mechanism
- For wall mounting with screws
- Can hold up to 20 keys or 14 code cards (787 LED) or up to 30 keys or 50 code cards (787 BIG LED)
- Easily removable clip-in hooks guarantee consumer's comfort
- Outer dimensions of housing: 84 x 120 x 42 (787 LED) / 84 x 120 x 62 (787 BIG LED)
- Ideal protected storage of keys and other valuables for authorised persons
- Quick and easy access for frequently changing groups of persons (craftsmen, service, holiday guests, apartment buildings, car rentals)
- Defining access by setting and passing on the code
- For wall mounting indoors and in protected outdoor areas

Ref. No.

EAN
4003318



mm



mm



mm

Weight
g

Box
Qty

787 BIG LED wall mounting

83856 9

84

62

120

721

4

787 BIG KEYGARAGE™



TECHNOLOGY



TECHNICAL DATA

- Very large solid metal housing and extra large storage compartment
- Locking cover made from zinc die-cast
- Individually resettable code (4-digit)
- Protective cover with sliding mechanism
- For wall mounting with screws
- Holds up to 30 cards or 38 keys
- Easily removable clip-in hooks guarantee consumer's comfort
- Flat inner mechanism makes a larger storage space possible
- Outer dimensions of housing: 84 x 120 x 62
- Ideal protected storage of keys and other valuables for authorised persons
- Quick and easy access for frequently changing groups of persons (craftsmen, service, holiday guests, apartment buildings, car rentals)
- Defining access by setting and passing on the code
- For wall fixing indoors and in protected outdoor areas
- Storage of a complete bunch of key now possible because of larger space and removable hook

Ref. No.

EAN
4003318



mm



mm



mm

Weight
g

Box
Qty

787 BIG wall mounting

08492 8

83,5

62

120,5

841

4

787 LED KEYGARAGE™



TECHNOLOGY



TECHNICAL DATA

- Solid metal housing
- Locking cover made of zinc die-cast
- 4-digit individually settable code
- Illuminated dials for a better legibility in dark conditions
- LEDs light up ca. 30 seconds
- Coin cell battery (CR2032) can be easily replaced, durability of battery when used 1x per day approximately 2 years
- Protective cover with sliding mechanism
- For wall mounting with screws
- Can hold up to 20 keys or 14 code cards (787 LED) or up to 30 keys or 50 code cards (787 BIG LED)
- Easily removable clip-in hooks guarantee consumer's comfort
- Outer dimensions of housing: 84 x 120 x 42 (787 LED) / 84 x 120 x 62 (787 BIG LED)
- Ideal protected storage of keys and other valuables for authorised persons
- Quick and easy access for frequently changing groups of persons (craftsmen, service, holiday guests, apartment buildings, car rentals)
- Defining access by setting and passing on the code
- For wall mounting indoors and in protected outdoor areas

Ref. No.

EAN
4003318



mm



mm



mm

Weight
g

Box
Qty

787 LED wall mounting

83854 5

84

42

120

698

1

787 KEYGARAGE™



TECHNOLOGY



TECHNICAL DATA

- Solid metal housing
- Locking cover made of zinc die-cast
- 4-digit individually settable code
- Protective cover with sliding mechanism
- For wall mounting with screws
- Can hold up to 20 keys or 14 code cards
- Outer dimensions of housing: 80 x 120 x 45
- Easily removable clip-in hooks guarantee consumer's comfort
- Ideal protected storage of keys and other valuables for authorised persons
- Quick and easy access for frequently changing groups of persons (craftsmen, service, holiday guests, apartment buildings, car rentals)
- Defining access by setting and passing on the code
- For wall mounting indoors and in protected outdoor areas

Ref. No.

EAN
4003318



mm



mm



mm

Weight
g

Box
Qty

787 silver wall mounting

46331 0

80

45

120

690

1

797 LED KEYGARAGE™



FEATURES



Adaptor



TECHNOLOGY



TECHNICAL DATA

- Solid metal housing
- Locking cover made of zinc die-cast
- 4-digit individually settable code 4-digit
- Illuminated dials for a better legibility in dark conditions
- LEDs light up ca. 30 seconds
- Coin cell battery (CR2032) can be easily replaced, durability of battery when used 1x per day approximately 2 years
- Protective cover with sliding mechanism
- Fixing with shackle, e.g. on a door knob of gates and doors
- Can hold up to 20 keys or 14 code cards
- Outer dimensions of housing: 84 x 119 x 44
- Housing and shackle plastic coated (protects door from scratching)
- Ideal protected storage of keys and other valuables for authorised persons
- Quick and easy access for frequently changing groups of persons (craftsmen, service, holiday guests, apartment buildings, car rentals)
- Defining access by setting and passing on the code
- Fixing with shackle, e.g. on a door knob of gates and doors

Ref. No.

Ref. No.	EAN 4003318	 mm	 mm	 mm	Weight g	Box Qty
797 LED with shackle	83855 2	84	44	120	779	1
Adapter KeyGarage™ 777 + 797	56321 8	70	74	63	114	1

797 KEYGARAGE™



FEATURES



Adaptor



TECHNOLOGY



TECHNICAL DATA

- Solid metal housing
- Locking cover made of zinc die-cast
- 4-digit individually settable code
- Protective cover with sliding mechanism
- Fixing with shackle, e.g. on a door knob of gates and doors
- Can hold up to 20 keys or 14 code cards
- Outer dimensions of housing: 85 x 120 x 45
- Housing and shackle plastic coated (protects door from scratching)
- Ideal protected storage of keys and other valuables for authorised persons
- Quick and easy access for frequently changing groups of persons (craftsmen, service, holiday guests, apartment buildings, car rentals)
- Defining access by setting and passing on the code
- Fixing with shackle, e.g. on a door knob of gates and doors

Ref. No.

Ref. No.	EAN 4003318	 mm	 mm	 mm	Weight g	Box Qty
797 with shackle	46330 3	85	45	180	767	1
Adapter KeyGarage™ 777 + 797	56321 8	70	74	63	114	1

767 KEYGARAGE™



TECHNOLOGY



TECHNICAL DATA

- Solid metal housing
- Locking cover made from zinc die-cast
- Code up to 10 digits individually resettable (the sequence of the code is irrelevant)
- Code needs to be entered in order to close the locking cover
- Plastic cover to protect against dust, dirt, etc.
- For wall fixing with screws
- Holds up to 17 cards or 20 keys
- Outer dimensions of housing: 84 x 119 x 47
- Ideal protected storage of keys and other valuables for authorised persons
- Quick and easy access for frequently changing groups of persons (craftsmen, service, holiday guests, apartment buildings, car rentals)
- Defining access by setting and passing on the code
- For wall fixing indoors and in protected outdoor areas

Ref. No.

EAN
4003318



mm



mm



mm

Weight
g

Box
Qty

767 Wandmontage

53507 9

80

45

120

657

1

ABUS TOUCH™ 57



TECHNICAL DATA

- Lock body made of coated zinc die cast
- Hardened Nano Protect™ shackle
- CR2 battery
- Capacitive sensor with minutiae detection
- 20 fingerprints can be stored
- Double ball locking
- Automatic locking
- Spring-loaded shackle for automatic opening
- IP certification IP66 & IP68
- For securing medium-value items when there is a medium risk of theft
- Use in clean areas with good fingerprint recognition
- Suitable for indoor and outdoor use

Ref. No.

EAN
4003318



mm



mm



mm



mm



mm



mm

Weight
g

Box
Qty

57/45 Touch™

62575 6

45

20

30

6,5

23

95

361

24

57/50 Touch™

62581 7

50

24

36

8

23

103

390

24



TECHNICAL DATA

- Solid aluminium lock body with anodized coating – corrosion resistant
- Spring loaded shackle for a better setting of the opening code
- 145/20 and 145/30: Individually resettable 3-digit code
- 145/40: Individually resettable 4-digit code
- Handy operation without key, low weight
- High value of recognition by intensive colours
- 145/20 and 145/30: To secure valuables/goods of lesser value or at a low risk of theft
- 145/40: To secure valuables/goods of medium value or at an average risk of theft
- E.g. to secure luggage, lockers in schools and sports centres, cash boxes, jewel cases, cupboards, tool boxes, switchboards, etc.

VERSIONS



145/20 yellow



145/20 orange



145/20 red



145/20 purple



145/20 blue









145/20 green



145/20 silver



145/20 titanium

Ref. No.	EAN 4003318	 mm	 mm	 mm	 mm	 mm	 mm	Weight g	Box Qty
145/20 yellow B/DFNLI	46552 9	22,5	9	22	3	13,5	52,5	25	6
145/20 orange B/DFNLI	46550 5	22,5	9	22	3	13,5	52,5	23	6
145/20 red B/DFNLI	46549 9	22,5	9	22	3	13,5	52,5	25	6
145/20 purple B/DFNLI	46553 6	22,5	9	22	3	13,5	52,5	25	6
145/20 blue B/DFNLI	46548 2	22,5	9	22	3	13,5	52,5	23	6
145/20 green B/DFNLI	46551 2	22,5	9	22	3	13,5	52,5	25	6
145/20 silver B/DFNLI	46554 3	22,5	9	22	3	13,5	52,5	25	6
145/20 titanium B/DFNLI	46556 7	22,5	9	22	3	13,5	52,5	23	6
145/20 black B/DFNLI	34609 5	22,5	9	22	3	13,5	52,5	23	6
145/30 yellow B/DFNLI	46561 1	31,5	14	25	5	15,5	65	52	6
145/30 orange B/DFNLI	46559 8	31,5	14	25	5	15,5	65	52	6
145/30 red B/DFNLI	46558 1	31,5	14	25	5	15,5	65	52	6
145/30 purple B/DFNLI	46562 8	31,5	14	25	5	15,5	65	52	6
145/30 blue B/DFNLI	46557 4	31,5	14	25	5	15,5	65	52	6
145/30 green B/DFNLI	46560 4	31,5	14	25	5	15,5	65	52	6
145/30 silver B/DFNLI	46563 5	31,5	14	25	5	15,5	65	52	6
145/30 titanium B/DFNLI	46565 9	31,5	14	25	5	15,5	65	52	6
145/30 black B/DFNLI	34610 1	31,5	14	25	5	15,5	65	52	6
145/40 yellow B/DFNLI	49534 2	41,5	21,5	26	6	17,5	77	105	6
145/40 orange B/DFNLI	49526 7	41,5	21,5	26	6	17,5	77	103	6
145/40 red B/DFNLI	48830 6	41,5	21,5	26	6	17,5	77	110	6
145/40 blue B/DFNLI	49522 9	41,5	21,5	26	6	17,5	77	105	6
145/40 green B/DFNLI	49530 4	41,5	21,5	26	6	17,5	77	105	6
145/40 silver B/DFNLI	49542 7	41,5	21,5	26	6	17,5	77	105	6
145/40 titanium B/DFNLI	49550 2	41,5	21,5	26	6	17,5	77	105	6

64 TITALIUM™



TECHNICAL DATA

- Solid lock body made from TITALIUM™ special aluminium
- Hardened steel shackle with NANO PROTECT™ coating for extreme corrosion resistance
- 64TI/50HB60-150: Removable and adjustable shackle from 60 mm to 150 mm
- Paracentric key profile for increased protection against manipulation
- Double bolted shackle
- Chrome-plated cylinder plug for additional corrosion protection
- Tulip-shaped key head
- Security for items/goods of medium value or where there is an average risk of theft
- For securing e.g. chains, doors, gates, cupboards, lockers, tool boxes, cellar windows or sheds

VERSIONS



64TI/20 B/DFNLI



64TI/25 B/DFNLI



64TI/30 B/DFNLI



64TI/30HB60 B/DFNLI



64TI/35 B/DFNLI



64TI/40HB40 B/DFNLI



64TI/40HB63 B/DFNLI



64TI/45 B/DFNLI

Ref. No.	EAN 4003318							Weight g	Box Qty
		mm	mm	mm	mm	mm	mm		
64TI/20 B/DFNLI	56384 3	20	9,5	11,5	3,5	10,5	34	22	6
64TI/25 B/DFNLI	56386 7	24,5	13	13,5	4	12	42	31	6
64TI/30 B/DFNLI	56387 4	30	16	17	5	13	50	54	6
64TI/30HB60 B/DFNLI	56388 1	30	16	60	5	13	93	66	6
64TI/35 B/DFNLI	56390 4	35	19	20	5,5	14	54	67	6
64TI/40 B/DFNLI	56391 1	40	22	23	6	15	62	88	6
64TI/40HB40 B/DFNLI	56392 8	40	22	40	6	15	79	96	6
64TI/40HB63 B/DFNLI	56393 5	40	22	63	6	15	102	107	6
64TI/45 B/DFNLI	56398 0	45	25	24	7	15	68	110	6
64TI/50 B/DFNLI	56399 7	50	28	29	8	17	77	159	6
64TI/50HB80 B/DFNLI	56400 0	50	28	80	8	17	128	199	6
64TI/50HB60-150 B/DFNLI	89490 9	50	28	60-150	8	17	77	281	4
64TI/50HB60-150 gl.	63308 9	50	28	60-150	8	17	77	281	3
64TI/60 B/DFNLI	56401 7	60	34	35	10	19	91	234	4

70 EXPEDITION



TECHNICAL DATA

- Solid lock body made from brass
- Shackle made from hardened steel with plastic sleeve
- Sealed lock body with special protective cap and drainage channels to protect the locking mechanism from water and dirt
- Shock-absorbing plastic casing protects sensitive surfaces
- Double bolted
- Precision pin cylinder
- Paracentric key profile for increased protection against manipulation
- Inner components made from rust-free materials
- Self-locking: lock without the key by pushing down the shackle
- Security for items/goods of medium value or where there is an average risk of theft
- For securing chains, doors, gates, cupboards, lockers, tool boxes, cellar windows, sheds, switch boxes, etc.
- Also suitable for outdoor use

FEATURE

VERSIONS



70I45HB63









70IB/45



70IB/50



70IB/45HB63

Ref. No.	EAN 4003318	 mm	 mm	 mm	 mm	 mm	 mm	Weight g	Box Qty
70I45 B/DFNLI	32130 6	49	20	24	8	27,5	74	179	6
70I45HB63 B/DFNLI	32131 3	49	20	63	8	27,5	112	201	6
70IB/45 B/DFNLI	32132 0	49	20	24	8	27,5	74	179	6
70IB/45HB63 B/DFNLI	35834 0	49	20	63	8	27,5	112	200	6
70IB/50 B/DFNLI	42733 6	55	23,5	27,5	9	31	81,5	233	6

24IB DISKUS®









TECHNICAL DATA

- Lock body, inner parts and shackle made solely from stainless steel for extreme resistance to corrosion
- Cylinder cover – maximum protection against dirt and water spray (60 mm and 70 mm only)
- Nickel-plated cylinder for enhanced weather protection
- Original Diskus® design: 360° protection
- Diskus® Deep-Welding Technology – the best in break-in protection
- Precision pin cylinder
- Key retaining: locking only with the key (key cannot be removed while the lock remains open)
- Made in Germany
- For the protection of larger assets and objects with a high risk of theft
- Ideal for severe weather conditions (e.g., in sea and port areas, for securing vehicles and boats in outdoor use)
- For securing trucks, doors, gates, barns, cellars, cupboards, etc.

FEATURE



Ref. No.	EAN 4003318	 mm	 mm	 mm	 mm	 mm	 mm	Weight g	Box Qty
24IB/50 B/DFNLI	32123 8	51	13	8	6,5	25,5	50	143	3
24IB/60 B/DFNLI	35042 9	60	17	13	8	26	60	195	6
24IB/70 B/DFNLI	32124 5	70	20	17	10	31	70	295	6

20 DISKUS®









FEATURES



TECHNICAL DATA

- Stainless steel - outside and inside
- Additional protection against sawing
- Shackle made from high quality stainless steel
- ABUS-Plus disc cylinder: highest protection against manipulation, extremely high number of key differs
- Cylinder cover – maximum protection against dirt and water spray
- Sophisticated Diskus® welded seam for highest break resistance
- Original Diskus® design: 360° protection
- Key retaining: key is needed for locking (lock retains key until locked)
- SZP: comes with security card to protect against unauthorized key duplicates
- Made in Germany
- 2 keys
- To secure valuables/goods of great value or at a very high risk of theft
- To secure e.g. warehouses, industrial sites, factory gates, containers and lorries
- Ideally used with ABUS Diskus® Hasp 140: virtually impossible to attack shackle

Ref. No.	EAN 4003318	 mm	 mm	 mm	 mm	 mm	 mm	Weight g	Box Qty
20/70 vs.	08854 4	70	20	17	10	30,5	70	306	6
20/80 vs.	08798 1	80	25	18	11	35,5	81	416	3
20/70 B/DFNLI	35023 8	70	20	17	10	30,5	70	308	3
20/80 B/DFNLI	35024 5	80	25	18	11	35,5	81	418	3

147TSA









TECHNOLOGY



TECHNICAL DATA

- Lock body made from plastic
- Shackle diameter 3 mm
- Individually resettable 3-digit code
- Visible red indicator at shackle: lock was opened by TSA. To reset red indicator open lock and turn shackle by 360°
- Para repor o indicador para uma nova viagem, rodar o arco 360°
- To secure valuables/goods of lower value or at a low risk of theft
- Suitable e.g. to secure luggage
- Ideal for journeys to the USA: the luggage can be opened/relocked by the US security authorities without damaging the lock

Ref. No.	EAN 4003318	 mm	 mm	 mm	 mm	 mm	 mm	Weight g	Box Qty
147TSA/30 B	53093 7	33	13	20	3	14	60	32	12

BRACKETS AND BAGS



**BRACKET
SH B**



black

Page 140

**BRACKET
USKF**



black

Page 140

**BRACKET
Eazy KF™**



black

Page 141

**BRACKET USH 540 /
470 / 460**



black

Page 141

**BRACKET
GH 50**



black

Page 142

**BRACKET
UGH 02**



black

Page 142

SHACKLE CLAMP



black

Page 142

**BRACKET
SADDLEFIX SH SF**



black

Page 143

**BRACKET
SH 6500A ONE**



black

Page 143

**BRACKET
SH 6500K BORDO™**



black

Page 143

**BRACKET
SH 6500 BORDO XPLUS™**



black

Page 144

**BRACKET
SH 6200K**



black

Page 144

**BRACKET
SH 6000 BORDO™**



black

Page 144

**BRACKET
SHFL BORDO MONKEYLINK**



black

Page 145

**BRACKET
SH 6000 BORDO™ BIG**



black

Page 145

**BRACKET
SH 5700 BORDO™**



black

Page 145

**BRACKET SH 5700
UGRIP BORDO™ BIG**



black

Page 146

**BRACKET
SR 6055 BORDO™ LITE**



black

Page 146

**BRACKET
SH 605 SELLE ROYAL**



black

Page 146

**BRACKET
ST 6000 BORDO™**



black

Page 147

**BRACKET ST 6000
BORDO™ BIG**



black

Page 147

**BRACKET ST 5700
UGRIP BORDO™**



black

Page 147

**BRACKET
IVERA RBU**



black

Page 148

**BRACKET
QUICK STORE QST**



black

Page 148

**CHAIN BAG
ST 2012**



black

Page 149

**SAC
ST 5850 / 5650 / 4960**



black

Page 149

**BRACKET
SNAP CAGE**



black

Page 149

**BRACKET
SCLL**



black

Page 150

**BRACKET
FIDLOCK FL**



black

Page 150

**BRACKET
FIDLOCK TEXFL**



black

Page 150

**BRACKET
TEXKF MINI**



black

Page 151

**BRACKET
QUICKSNAP RBU**



black

Page 151

**BRACKET
FMU 6950**



black

Page 151

**SPANNBAND
LH- ADAPTER**



black

Page 152

ST 5050



black

Page 152



ST 1010

black

Page 152



**ORYDE
ST 2250**

black

Page 153



**ORYDE
ST 2200**

black

Page 153



**ORYDE
ST 2085**

black

Page 153



**ORYDE
ST 2100**

black

Page 154



**BASICO
ST 5200**

black

Page 154



ST 5950 2.0

black

Page 154

CARRIER SH B



TECHNICAL DATA

- Universal shackle lock holder for many ABUS U-locks
- The holder is suitable for U-locks with up-to a 14 mm square as well as a 16 mm round shackle
- Allows the lock to be transported to different places on the bike
- The holder allows for vertical or horizontal attachment to the frame
- Suitable for U-locks 640, 540, 470, 460
- Fast and intuitive handling
- Suitable for frame diameters from 20-55 mm
- Universal bracket for the use of various U-locks

Ref. No.	EAN 4003318	Version	Weight g	Carrier	Box Qty
Bracket SH B	67899 8		150	for 640, 540, 470, 460	1

BRACKET USKF



TECHNICAL DATA

- Transport of U-shackle locks
- Mounting on round frames with a diameter of 18-70 mm
- Plastic bracket with rubber inlays for best mounting
- Comfortable one-hand-operation
- Easy and quick mounting

Ref. No.	EAN 4003318	Weight g	Carrier	Box Qty
Bracket USKF	86143 7	65	for 64/46/47/770A/540/460/470/640	1

BRACKET EAZY KF™



TECHNICAL DATA

- Transport of U-shackle locks
- Mounting on round frames with a diameter of 28 - 36 mm
- Screws in two lengths included
- Plastic bracket for mounting with rubber inlays for best hold
- Index marks on the bracket to simplify subsequent mountings
- Comfortable one-hand-operation
- Very quick mounting
- Patented design

Ref. No.	EAN 4003318	Version	Weight g	Carrier	Box Qty
Halter EaZy KF™	45342 7		95	for 64/61/54/51/47/540/470	1
Bügelklemme 11 mm	45344 1	Ø 11 mm	22	for 61/64 EaZy KF	1
Bügelklemme 12 mm	45347 2	Ø 12 mm	24	for 47 EaZy KF/470	1
Bügelklemme 13 mm	45343 4	Ø 13 mm	26	for 540	1
Bügelklemme 13 mm	45346 5	Ø 13 mm	28	for 51/501	1

BRACKET USH540 / 470 / 460



TECHNICAL DATA

- Transport of U-shackle locks
- Mounting on round frames with a diameter of 15 - 35 mm
- Plastic bracket for mounting
- Mounting within the frame or at the side possible

Ref. No.	EAN 4003318	Version	Weight g	Carrier	Box Qty
Bracket USH 540	18576 2		150	for 540	1
Bracket USH 460 / 470	18578 6		120	for 460 / 470 / 32	1

BRACKET GH 50



TECHNICAL DATA

- Transport of round U-shackle locks with a diameter up to 17 mm
- Mounting on the side of the rack
- Plastic bracket for mounting

Ref. No.	EAN 4003318	Version	Weight g	Carrier	Box Qty
Bracket GH 50	00904 4		196	for ABUS No. 64, 51, 47, 46, 470, 460, 32	1

BRACKET UGH 02



TECHNICAL DATA

- Transport of Steel-O-Flex and other locks
- Mounting on the rack stays with a diameter of 5 - 16.5 mm
- Universal solution for all common racks
- Simple and time saving mounting

Ref. No.	EAN 4003318	Version	Weight g	Carrier	Box Qty
Bracket UGH 02	26624 9		80	for 950, 970, 1025, 1050, 8200, 8220, 7200, 7220	1

SHACKLE CLAMP



TECHNICAL DATA

- Accessory for the transport in a TUBUS LOCC U-shackle lock carrier, TexKF Twin or RBKF Twin

Ref. No.	EAN 4003318	Version	Weight g	Carrier	Box Qty
Shackle Clamp 12mm	25604 2	∅ 12 mm	21	for 46, 47, 460, 470	1
Shackle Clamp	27348 3	∅ 13 mm	30	for 540	1

BRACKET SH SF SADDLEFIX



TECHNICAL DATA

- Universal adapter for space-saving attachment of various BORDO™ locks to saddle stays
- Your desired BORDO™ lock can be fixed to the adapter together with the corresponding bracket
- A rain cap is included in the scope of delivery: as splash and weather protection for your BORDO™ lock
- The holes on the adapter are analogous to those on a water bottle holder, so that this or the SportFlex lock could also be fixed to the adapter
- Screws are included in the scope of delivery
- Adapter for attachment to the saddle
- Suitable for brackets SH 5700, 6000 and 6500
- Practical rain cover and protection against dirt and moisture

Ref. No.	EAN 4003318	Version	Weight g	Carrier	Box Qty
Bracket SH SF	67866 0	with Rain Cap	121	for SH 5700C/80, SH 5700K/80, SH 6000C/90, SH 6000K/120, SH 6000K/90, SH 6500/85	3

BRACKET SH 6500A ONE



TECHNICAL DATA

- For easy transportation of the BORDO 6500A One
- Simple mounting with fixing strap or Velcro strap
- Does not require much space, as the lock can be removed from the front
- Ideal for small frame geometries

Ref. No.	EAN 4003318	Version	Weight g	Carrier	Box Qty
Bracket SH 6500A One	63488 8		148	for 6500A/110	1

BRACKET SH 6500K BORDO™



TECHNICAL DATA

- For easy transportation of the BORDO 6500K and 6500KA
- Simple mounting with the supplied tensioning straps
- Fits in compact spaces thanks to front loading of the lock
- Ideal for smaller frame sizes
- Holder for the secure transport of locks on the bike

Ref. No.	EAN 4003318	Version	Weight g	Carrier	Box Qty
Bracket SH 6500K/90	69051 8		195	for 6500KA/90, 6500K/90	3
Bracket SH 6500K/120	96279 0		230	for 6500K/120	1

BRACKET SH 6500 BORDO XPLUS™



TECHNICAL DATA

- Easy transport for BORDO™ 6500
- Simple mounting due to practical mounting straps
- The lock can be easily removed forwards
- Perfect for small framed bikes

Ref. No.	EAN 4003318	Version	Weight g	Carrier	Box Qty
Bracket SH 6500/110	61556 6		172	for 6500/110	3

BRACKET SH 6200K



TECHNICAL DATA

- For easy transport of the BORDO 6200K
- Simple installation thanks to practical fixing strap holder
- Does not require much space, as the lock can be removed from the front
- Ideal for small frame geometries

Ref. No.	EAN 4003318	Version	Weight g	Carrier	Box Qty
Bracket SH 6200K/90	94474 1		165	for 6200K	3

BRACKET SH 6000 BORDO™



TECHNICAL DATA

- Easy transport for BORDO™ 6000, 6015 and 6100
- Simple installation due to practical mounting straps
- The lock can be easily removed forwards
- Perfect for small framed bikes

Ref. No.	EAN 4003318	Version	Weight g	Carrier	Box Qty
Bracket SH 6000/90	61543 6		115	for 6000/90, 6000K/90, 6000KA/90, 6000C/90, 6000A/90, 6100/90	3

BRACKET SHFL BORDO MONKEYLINK



TECHNICAL DATA

- For easy transportation of the BORDO 6000K/90, 6000C/90 or the 6000KA/90
- Simple and super-fast magnetic attachment to the Fidlock TWIST bike base
- Does not require much space, as the lock can be removed from the front
- The BORDO 6000K/90 and 6000C/90 are also available individually without brackets
- Fidlock TWIST base is not included

Ref. No.	EAN 4003318	Version	Weight g	Carrier	Box Qty
Bracket SHFL 6000/90	88886 1		160	for 6000/90, 6100/90, 6000A/90, 6000K/90, 6000C/90, 6000KA/90	3

BRACKET SH 6000 BORDO™ BIG



TECHNICAL DATA

- Easy transport for BORDO™ 6000 BIG
- Simple mounting thanks to supplied tensioning straps
- The lock can be easily removed forwards
- Perfect for small framed bikes

Ref. No.	EAN 4003318	Version	Weight g	Carrier	Box Qty
Bracket SH 6000/120	61564 1		132	for 6000/120, 6000K/120, 6000KA/120, 6000A/120	3

BRACKET SH 5700 BORDO



TECHNICAL DATA

- Easy transport for BORDO 5700K uGrip
- Simple mounting thanks to supplied tensioning straps
- The lock can be easily removed forwards
- Perfect for small framed bikes

Ref. No.	EAN 4003318	Version	Weight g	Carrier	Box Qty
Bracket SH 5700/80	61566 5		122	for 5700K/80 and 5700C/80	3

BRACKET SH 5700 UGRIP BORDO BIG



TECHNICAL DATA

- Easy transport for BORDO 5700 uGrip BIG
- Simple mounting thanks to supplied tensioning straps
- The lock can be easily removed forwards
- Perfect for small framed bikes

Ref. No.	EAN 4003318	Version	Weight g	Carrier	Box Qty
Bracket SH 5700K/100	61571 9		122	for 5700/100	3

BRACKET SH 6055 BORDO™ LITE



TECHNICAL DATA

- Easy transport for BORDO™ 6055 Lite
- Simple and toolless mounting due to practical mounting straps
- The lock can be easily removed forwards
- Perfect for small framed bikes

Ref. No.	EAN 4003318	Version	Weight g	Carrier	Box Qty
Bracket SH 6055	61572 6		60	for 6055K/60, 6055K/85, 6055C/60 and 6055C/85	3

BRACKET SH 6055 SELLE ROYAL



TECHNICAL DATA

- For easy transportation of the BORDO 6055 Lite and Lite Mini (both Key and Combo variants)
- Easy mounting under Selle Royal saddles
- Ideal for use on road bikes

Ref. No.	EAN 4003318	Version	Weight g	Carrier	Box Qty
Bracket SR 6055 Selle Royal	63151 1		64	for 6055K/60, 6055K/85, 6055C/60 and 6055C/85	3

BRACKET ST 6000 BORDO™



TECHNICAL DATA

- Flexible mounting with non-slip velcro straps or bolts using the bottle cage fittings
- Easy transport thanks to practical holder

Ref. No.	EAN 4003318	Version	Weight g	Carrier	Box Qty
Bracket ST 6000/90 black	54297 8		125	for 6000K/90, 6000C/90	1

BRACKET ST 6000 BORDO™ BIG



TECHNICAL DATA

- Flexible mounting with non-slip velcro straps or bolts using the bottle cage fittings
- Easy transport thanks to practical holder

Ref. No.	EAN 4003318	Version	Weight g	Carrier	Box Qty
Bracket ST 6000/120 black	55327 1		160	for 6000K/120	1

BRACKET ST 5700 UGRIP BORDO™



TECHNICAL DATA

- Transport bag with latching mechanism and comfortable one-hand-operation
- Flexible mounting with non-slip velcro straps or bolts using the bottle cage fittings
- Easy transport thanks to practical holder

Ref. No.	EAN 4003318	Version	Weight g	Carrier	Box Qty
Bracket ST 5700 uGrip BORDO	11284 3		103	for 5700K/80	1

BRACKET IVERA RBU



TECHNICAL DATA

- Transport of chain, cable and Steel-o-flex locks of the Ivera series
- For mounting on round and non-round frame profiles with a diameter of 15 - 45 mm or for practical mounting on the seat clamp
- Easy mounting with a metal sleeve or LL bracket

Ref. No.	EAN	Version	Weight g	Carrier	Box Qty
Bracket IVERA RBU	4003318 58497 8		125	for 7200, 7210, 7220 IVERA	1

QUICKSTORE QST HOLDER



TECHNICAL DATA

- For transporting chain locks securely with no rattling
- For ABUS chain locks with 6 mm thickness and 85-110 cm length
- Easy mounting with screws on the bottle holder or by means of practical fixing strap carrier
- Can be combined with the SaddleFix holder (SF QST) for mounting under the saddle
- Stowage and transport option for chain locks

Ref. No.	EAN	Version	Weight g	Carrier	Box Qty
Bracket QST	4003318 61493 4		260	for Catena 6806K	6

CHAIN BAG ST 2012



TECHNICAL DATA

- Bag designed for the protected transport of lock-chain-combinations
- Flexible mounting with non-slip velcro straps or screws at the bottle holder device
- 2 mm strong neoprene to keep the content cool or warm
- Strengthened inner-plate for easy mounting

Ref. No.	EAN 4003318	Version	Weight g	Box Qty
ST 2012 Chain Bag	58496 1	Transport bag 0.6 l	188	1

BAG ST 5850/5650/4960



TECHNICAL DATA

- Bag for the protected transport of frame locks and accessories
- Convenient mounting on the carrier

Ref. No.	EAN 4003318	Version	Weight g	Box Qty
ST 5850/5650/4960	48647 0	Transport bag 160 mm / 250 mm / 50 mm	100	1

BRACKET SNAP CAGE



TECHNICAL DATA

- Transport of Steel-O-Flex, cable- and coil cable locks
- Enables transporting the lock on the seat post, on the frame and on the rack stays
- With a diameter of 15 - 55 mm
- Simple mounting without tools

Ref. No.	EAN 4003318	Version	Weight g	Carrier	Box Qty
Bracket Snap Cage MU 6K	20079 3		40	for 6412K, 6512K, 6615K	12
Bracket Snap Cage MU 4K/5K	20080 9		40	for 4508K, 5510K, 5412K	12
Bracket Snap Cage MU 4C/5C	20111 0		40	for 4508C, 5510C, 5412C	12
Bracket Snap Cage MU 6C	20113 4		40	for 6412C, 6512C, 6615C	12

BRACKET SCLL



TECHNICAL DATA

- Transport of cable, coil cable and Steel-0-Flex locks
- Mounting on all common seat post bolts (diameter 5-8 mm)
- Easy mounting

Ref. No.	EAN 4003318	Version	Weight g	Carrier	Box Qty
Bracket SCLL 6K	87984 5		47	for 6412K, 6512K, 6615K	12
Bracket SCLL 4C/5C	87981 4		47	for 4508C, 5412C, 5510C	12

BRACKET FL



TECHNICAL DATA

- Exclusively for the transport of the Phantom 8960, 8950 and 8940
- For the effortless magnetic mounting on and handy removal from the bracket
- Mounting on all common seat post bolts (diameter 5-8 mm)
- Easy mounting

Ref. No.	EAN 4003318	Version	Weight g	Carrier	Box Qty
Bracket FL	39729 5		61	for Phantom 8960, 8950, 8940	1

BRACKET TEXFL



TECHNICAL DATA

- Exclusively for the transport of the Phantom 8960, 8950 and 8940
- For the effortless magnetic mounting on and handy removal from the bracket
- Mounting on round and non-round frame profiles with a diameter of 21 - 80 mm
- Flexible textile sleeve for mounting

Ref. No.	EAN 4003318	Version	Weight g	Carrier	Box Qty
Bracket TexFL	39730 1		77	for Phantom 8960, 8950, 8940	1

BRACKET TEXKF MINI



TECHNICAL DATA

- Transport mostly cable, coil cable and Steel-0-Flex locks
- Mounting on round and non-round frame profiles with a diameter of 21 - 80 mm
- Flexible textile sleeve for mounting
- Mounting within the frame or at the side possible
- Simple and time saving mounting

Ref. No.	EAN 4003318	Version	Weight g	Carrier	Box Qty
Bracket TexKF Mini	23265 7		70	for 640, 1460, 8950, 1450, 8940	1

BRACKET QUICKSNAP RBU



TECHNICAL DATA

- Transport of cable and Steel-0-Flex locks
- Mounting on round and non-round frame profiles with a diameter of 15 - 45 mm
- Flexible metal sleeve for mounting
- Mounting within the frame or at the side possible
- Simple and time saving mounting

Ref. No.	EAN 4003318	Version	Weight g	Carrier	Box Qty
Bracket QuickSnap RBU	31487 2		40	for 860, 870	6

FMU 6950



TECHNICAL DATA

- For attaching frame locks to bicycle frames

Ref. No.	EAN 4003318	Version	Weight g	Carrier	Box Qty
FMU 6950 2 pieces	96201 1		40		1

MOUNTING STRAP LH ADAPTOR



TECHNICAL DATA

- Mounting of frame locks to the bike frame

Ref. No.	EAN 4003318	Version	Weight g	Carrier	Box Qty
Mounting strap LH adaptor	56240 2		48	for all ABUS frame locks	1

ST 5050



TECHNICAL DATA

- Bag is attached under the saddle with two Velcro straps
- 2 mounting options: Velcro strap can be routed through tabs on the front and back
- Bag opens to the side: left or right, depending on how it is attached
- Water-repellent fabric protects the contents of the bag
- Saddle bag for insert chains up to 130 cm long

Ref. No.	EAN 4003318	Capacity l	Width mm	Height mm	Depth mm	Version	Box Qty
ST 5050	40992 9	1	95	75	150	Velcro strap	60

ST 1010



TECHNICAL DATA

- Robust multi use bag made of nylon with handle
- Practical for transporting chain locks, tools and small parts

Ref. No.	EAN 4003318	Capacity l	Width mm	Height mm	Depth mm	Version	Box Qty
ST 1010	23207 7	2	270	170	45		1

ORYDE ST 2250



TECHNICAL DATA

- 1.8 litres stowing capacity
- Water-repellent and robust materials 420D and Scotch Rip 58
- Stable shape
- Reflective applications
- Practical interior design with key hook
- Very ample main compartment
- Frame bag for every day and leisure use

Ref. No.	EAN	Capacity l	Width mm	Height mm	Depth mm	Version	Box Qty
ST 2250	4003318 08469 0	1,8	235	195	50	Velco Straps	1

ORYDE ST 2200



TECHNICAL DATA

- 1.2 litres stowing capacity
- Water-repellent and robust materials 420D and Scotch Rip 58
- Stable shape
- Reflective applications
- Practical interior design with key hook
- Very ample main compartment
- Frame bag for every day and leisure use

Ref. No.	EAN	Capacity l	Width mm	Height mm	Depth mm	Version	Box Qty
ST 2200	4003318 08470 6	1,2	255	100	50	Velco Straps	1

ORYDE ST 2085



TECHNICAL DATA

- 0.7 litre stowing capacity
- Water-repellent and robust materials 420D and Scotch Rip 58
- Stable shape
- Reflective applications
- Practical interior design with key hook
- Particularly simple to fill due to ABUS Easy Flap System
- Includes rain cover with reflective logo
- Saddle bag for every day, sport and leisure use

Ref. No.	EAN	Capacity l	Width mm	Height mm	Depth mm	Version	Box Qty
ST 2085 KF	4003318 08479 9	0,7	75	70	145	KLICKfix® Saddle Bracket	1

ORYDE ST 2100



TECHNICAL DATA

- 1.2 litre stowing capacity
- Water-repellent and robust materials 420D and Scotch Rip 58
- Stable shape
- Reflective applications
- Practical interior design with key hook
- Expandable pullout to increase stowing capacity
- Saddle bag for every day, sport and leisure use

Ref. No.	EAN 4003318	Capacity l	Width mm	Height mm	Depth mm	Version	Box Qty
ST 2100 KF	08472 0	1,2	80	95	150	KLICKfix®	6

BASICO ST 5200



TECHNICAL DATA

- 1.2 litres stowing capacity
- Water repellent and robust material
- Practical interior design
- Very ample main compartment
- Reflective applications
- Frame bag for every day and leisure use

Ref. No.	EAN 4003318	Capacity l	Width mm	Height mm	Depth mm	Version	Box Qty
ST 5200	08482 9	1,2	255	110	65	Velcro straps	1

ST 5950 2.0



TECHNICAL DATA

- Saddle bag for every day, sport and leisure use

Ref. No.	EAN 4003318	Capacity l	Width mm	Height mm	Depth mm	Version	Box Qty
ST 5950 2.0	87510 6	0,6	160	85	90	Velcro straps	1



ABUS OEM

STRONG SERVICE PARTNER, RELIABLE SUPPLIER ABUS AS OEM PARTNER – YOUR FIRST CHOICE



In the bicycle market, the factors of success are added value, differentiation, flexibility, availability, fast service and high capacity. Suppliers that work with bicycle manufacturers have to meet the corresponding requirements. ABUS meets them.

As a globally experienced specialist in bicycle security, we offer you the best possible support and a high level of reliability. For years, ABUS has been a synonym for security, and has earned a leading position in the bicycle accessory market.

Quality „Made in Germany“ and „Just in time“ deliveries: concentrating on these core competences has made us an important partner for many bicycle manufacturers worldwide. We are also a strong partner on the OEM market, offering a wide selection of frame locks, integrated security solutions, and many individualized products. Among others, we offer keyed alike locks and battery cylinders for e-bikes.

Allow us to take advantage of mutual synergy and implement it to our shared success!

Our OEM team looks forward to hearing from you at: oem@abus.de

We hope to continue our good cooperation with leading bicycle manufacturers!





CUSTOM SECURITY

Custom security solutions are not just a trend, but also a very convenient way for cyclists to secure their beloved bicycles. Take advantage of our more than 100 years of experience, and set yourself apart from the masses with a customized security solution.

ADVANCED®

Bianchi
LIFE®

BERGAMONT

BULLS

CANYON

corratec

 CUBE FLYER HAIBIKE

HERCULES

 Husqvarna®
E-BICYCLES

KETTLER ALU-RAD

KTM
BIKE INDUSTRIES

MCG
MERIDA & CENTURION GERMANY GMBH

ORBEA

RIESE & MÜLLER

SCOTT

SERIAL

 SIMPLON

 SPECIALIZED

STEVENS
BIKES

tern 

TREK

URBAN ARROW®

VELO@VILLE

zemo 
zero emission mobility



Security Tech Germany

**THIS
IS
PURE**



abus.com

PURE EDITION

UNIQUE, COOL DESIGN

Discover some of our tried-and-tested bike helmet models in trendy pastel colours - the fashionable highlight for the summer!

The EPS is now in bright white for a fresh look. Get these hot helmets for your customers!

HUD-Y ACE



pure aqua Page 224	pure mint Page 224	pure lavender Page 224	pure rose Page 224	pure white Page 224
-----------------------	-----------------------	---------------------------	-----------------------	------------------------

HUD-Y



pure mint Page 226	pure aqua Page 226	pure lavender Page 226	pure rose Page 226	pure white Page 226	puristic Page 226
-----------------------	-----------------------	---------------------------	-----------------------	------------------------	----------------------

SMILEY 3.0 ACE



pure rose Page 268	pure mint Page 268	pure lavender Page 268	pure aqua Page 268	pure white Page 268
-----------------------	-----------------------	---------------------------	-----------------------	------------------------

AIRBRAKER



pure grey Page 170	pure mint Page 170	pure white Page 170
-----------------------	-----------------------	------------------------

GAMECHANGER 2.0



pure white Page 174	pure mint Page 174
------------------------	-----------------------

STORMCHASER ACE



pure grey Page 174	pure mint Page 176	pure grey Page 176	pure white Page 176
-----------------------	-----------------------	-----------------------	------------------------





ROAD



AIRBREAKER



pure grey

Page 170



pure mint

Page 170



pure white

Page 170

Movistar Team
24

Page 170

performance
red

Page 170



goldfish orange

Page 170



polar white

Page 170



moss green

Page 170



velvet black

Page 170



race grey

Page 170

polar white
shiny

Page 170



gleam silver

Page 170



flip flop

Page 170



dark grey

Page 170



black gold

Page 170

GAMECHANGER TT 1.1



shiny white

Page 172



shiny black

Page 172

GAMECHANGER 2.0



pure white

Page 174



pure mint

Page 174



pure grey

Page 174



Movistar Team
24

Page 174



velvet black

Page 174



titan

Page 174



race grey

Page 174



shiny white

Page 174



performance
red

Page 174



flip flop purple

Page 174



goldfish orange

Page 174



gleam silver

Page 174



moss green

Page 174



polar white

Page 174



black gold

Page 174



performance
red

Page 174



velvet black

Page 174



shiny white

Page 174



flip flop purple

Page 174

STORMCHASER ACE



pure mint

Page 176



pure grey

Page 176



pure white

Page 176



velvet black

Page 176



race grey

Page 176



performance
red

Page 176



flip flop purple

Page 176



polar white

Page 176

POWERDOME ACE



moss green

Page 178



race grey

Page 178



metallic copper

Page 178

POWERDOME



gleam silver

Page 180



polar white

Page 180



velvet black

Page 180



shiny black

Page 180



titan

Page 180



shiny white

Page 180



goldfish orange

Page 180



blaze red

Page 180



flip flop purple

Page 180



gleam silver

Page 180



polar white

Page 180



velvet black

Page 180



shiny black

Page 180



titan

Page 180



shiny white

Page 180



goldfish orange

Page 180



blaze red

Page 180



flip flop purple

Page 180

WINGBACK



flip flop purple

Page 182



velvet black

Page 182



titan

Page 182



race grey

Page 182



shiny white

Page 182



performance red

Page 182



goldfish orange

Page 182



gleam silver

Page 182



moss green

Page 182



polar white

Page 182

MACATOR



white silver

Page 184



velvet black

Page 184



titan

Page 184



steel blue

Page 184



signal yellow

Page 184



shiny rose

Page 184



race grey

Page 184



pearl white

Page 184



midnight blue

Page 184



gleam silver

Page 184



blaze red

Page 184



matt black

Page 184



matt blue

Page 184



signal yellow

Page 184



pearl white

Page 184



shiny black

Page 184



PRODUCT FEATURE MATRIX



SHELLS	4	5	4	2
LOWER SHELL	✓	✓	✓	-
EYEWEAR PORT	✓	✓	✓	-
GRIDS	✓	✓	-	-

RETENTION SYSTEM	ZOOM	ZOOM PRO	ZOOM PRO	ZOOM ACE
PADDING	FLOATING	FLOATING PRO	FLOATING	FLOATING
STRAPS	FLOWSTRAPS	FLOWSTRAPS PRO	FLOWSTRAPS	FLOWSTRAPS
WEIGHT	200g	260g	220g	220g
BOX	SLIDER	SLIDER	EASY	EASY
PRODUCTION	ITALY	ITALY	ITALY	ITALY
VISOR / PEAK	-	-	-	-
ADD-ONS	-	Mips	-	Mips
SIZES	S/M/L	S/M/L	S/M/L	S/M/L

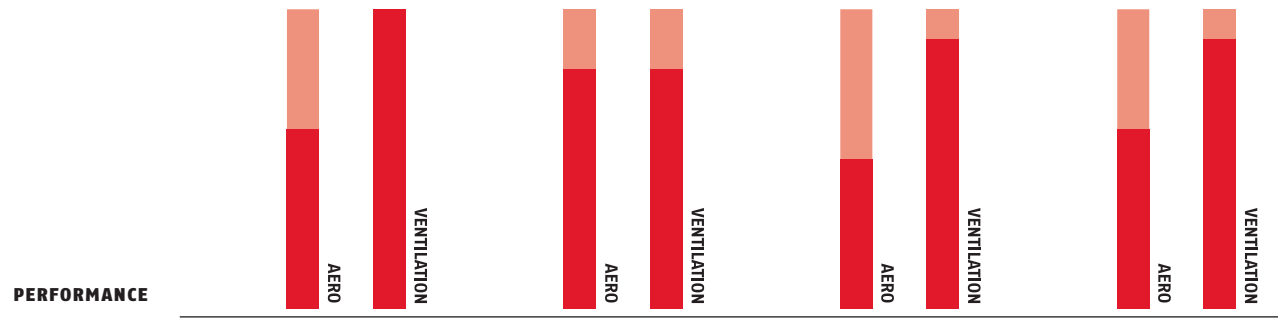

WINGBACK MACATOR GAMECHANGER TT 1.1

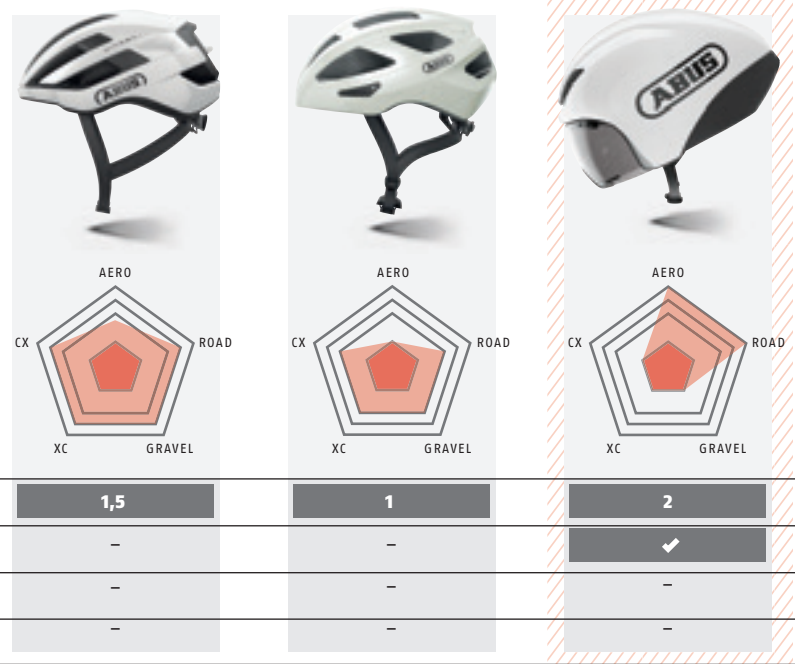

SHELLS	1,5	1	2
LOWER SHELL	-	-	✓
EYEWEAR PORT	-	-	-
GRIDS	-	-	-

RETENTION SYSTEM	ZOOM ACE	ZOOM ACE	ZOOM
PADDING	VELCRO	VELCRO	FLOATING
STRAPS	FLOWSTRAPS	DIVIDER	FLOWSTRAPS
WEIGHT	240g	300g	360g
BOX	EASY	SIMPLE	EASY
PRODUCTION	ITALY	CHINA	ITALY
VISOR / PEAK	-	✓	✓
ADD-ONS	-	Mips	-
SIZES	S/M/L	S/M/L	S/M/L

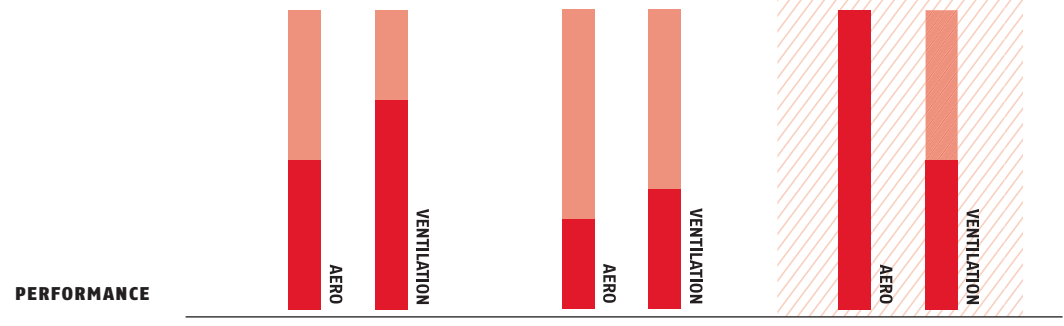

PERFORMANCE

AIRBREAKER

VIEWS



pure grey



pure grey



FEATURES



Zoom Ace



Buckle



FlowStraps



Grid



EyewearPort

TECHNOLOGY



VERSIONS



pure mint



pure white



Movistar Team 24



performance red



goldfish orange



polar white matt



moss green



velvet black



race grey



polar white



gleam silver



flip flop



dark grey



black gold

Ref. No.	EAN 4003318	Colour	Finish	Weight g	Size	Head size cm
AirBreaker	40433 7	pure grey	shiny	200	S	51 - 55
AirBreaker	38065 5	pure grey	shiny	210	M	52 - 58
AirBreaker	94324 9	pure grey	shiny	230	L	59 - 61
AirBreaker	40950 9	pure mint	matt+shiny	200	S	51 - 55
AirBreaker	40432 0	pure mint	matt+shiny	210	M	52 - 58
AirBreaker	38064 8	pure mint	matt+shiny	230	L	59 - 61
AirBreaker	94323 2	pure white	shiny	200	S	51 - 55
AirBreaker	40949 3	pure white	shiny	210	M	52 - 58
AirBreaker	40431 3	pure white	shiny	230	L	59 - 61
AirBreaker	40928 8	Movistar Team 24	shiny	200	S	51 - 55
AirBreaker	94304 1	Movistar Team 24	shiny	210	M	52 - 58
AirBreaker	38043 3	Movistar Team 24	shiny	230	L	59 - 61
AirBreaker	97973 6	performance red	shiny	200	S	51 - 55
AirBreaker	97974 3	performance red	shiny	210	M	52 - 58
AirBreaker	97975 0	performance red	shiny	230	L	59 - 61
AirBreaker	97976 7	goldfish orange	shiny	200	S	51 - 55
AirBreaker	97977 4	goldfish orange	shiny	210	M	52 - 58
AirBreaker	97978 1	goldfish orange	shiny	230	L	59 - 61
AirBreaker	97980 4	polar white matt	matt	200	S	51 - 55
AirBreaker	97981 1	polar white matt	matt	210	M	52 - 58
AirBreaker	97982 8	polar white matt	matt	230	L	59 - 61
AirBreaker	97983 5	moss green	shiny	200	S	51 - 55
AirBreaker	97984 2	moss green	shiny	210	M	52 - 58
AirBreaker	97985 9	moss green	shiny	230	L	59 - 61
AirBreaker	81719 9	velvet black	matt	200	S	51 - 55
AirBreaker	81720 5	velvet black	matt	210	M	52 - 58
AirBreaker	81721 2	velvet black	matt	230	L	59 - 61
AirBreaker	40278 4	race grey	shiny	200	S	51 - 55
AirBreaker	40279 1	race grey	shiny	210	M	52 - 58
AirBreaker	40280 7	race grey	shiny	230	L	59 - 61
AirBreaker	81731 1	polar white	shiny	200	S	51 - 55
AirBreaker	81732 8	polar white	shiny	210	M	52 - 58
AirBreaker	81733 5	polar white	shiny	230	L	59 - 61
AirBreaker	81740 3	gleam silver	matt	200	S	51 - 55
AirBreaker	81741 0	gleam silver	matt	210	M	52 - 58
AirBreaker	81742 7	gleam silver	matt	230	L	59 - 61
AirBreaker	87512 0	flip flop purple	shiny	200	S	51 - 55
AirBreaker	87513 7	flip flop purple	shiny	210	M	52 - 58
AirBreaker	87514 4	flip flop purple	shiny	230	L	59 - 61
AirBreaker	86844 3	dark grey	shiny	200	S	51 - 55
AirBreaker	86845 0	dark grey	shiny	210	M	52 - 58
AirBreaker	86846 7	dark grey	shiny	230	L	59 - 61
AirBreaker	86829 0	black gold	matt	200	S	51 - 55
AirBreaker	86830 6	black gold	matt	210	M	52 - 58
AirBreaker	86831 3	black gold	matt	230	L	59 - 61
Race Cap	96047 5	autumn black			M/L	56 - 61
Race Cap	96048 2	porto blue			M/L	56 - 61
Race Cap	96049 9	italian white			M/L	56 - 61
Race Cap	96046 8	adventure blue			M/L	56 - 61
ABUS Bag	78592 4	black				universal
Helmet bag sportiv	68451 7	black				universal



GAMECHANGER TT 1.1

VIEWS



shiny white



shiny white



FEATURES



Zoom Ace



Fidlock

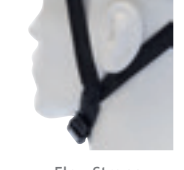

FlowStraps



Magnetic glass

TECHNOLOGY



VERSIONS



shiny black

Ref. No.	EAN 4003318	Colour	Finish	Weight g	Size	Head size cm
GameChanger TT 1.1	94335 5	shiny white	shiny		S	51 - 55
GameChanger TT 1.1	40961 5	shiny white	shiny		M	54 - 58
GameChanger TT 1.1	40443 6	shiny white	shiny		L	57 - 61
GameChanger TT 1.1	38075 4	shiny black	shiny		S	51 - 55
GameChanger TT 1.1	94334 8	shiny black	shiny		M	54 - 58
GameChanger TT 1.1	40960 8	shiny black	shiny		L	57 - 61
Visor clear S	38199 7	clear			S	
Visor clear M	94470 3	clear			M	
Visor clear L	41082 6	clear			L	
Visor smoke S	38200 0	smoke			S	
Visor smoke M	94471 0	smoke			M	
Visor smoke L	41083 3	smoke			L	
Visor chrome S	38198 0	chrome			S	
Visor chrome M	94469 7	chrome			M	
Visor chrome L	41081 9	chrome			L	

Road



GAMECHANGER 2.0

NEW

VIEWS



pure white



pure white



FEATURES



Zoom Ace



Buckle



FlowStraps



EyewearPort

TECHNOLOGY



Visit our campaign website

VERSIONS



pure mint



pure grey



Movistar Team 24



velvet black



titan



race grey



shiny white



performance red



flip flop purple



goldfish orange



gleam silver



moss green



polar white



black gold



velvet black



shiny white



performance red



flip flop purple

Ref. No.	EAN 4003318	Colour	Finish	Weight g	Size	Head size cm
GameChanger 2.0	38066 2	pure white	shiny	260	S	51 - 55
GameChanger 2.0	94325 6	pure white	shiny	265	M	54 - 58
GameChanger 2.0	40951 6	pure white	shiny	275	L	57 - 61
GameChanger 2.0	94326 3	pure mint	matt+shiny	260	S	51 - 55
GameChanger 2.0	40952 3	pure mint	matt+shiny	265	M	54 - 58
GameChanger 2.0	40434 4	pure mint	matt+shiny	275	L	57 - 61
GameChanger 2.0	40953 0	pure grey	shiny	260	S	51 - 55
GameChanger 2.0	40435 1	pure grey	shiny	265	M	54 - 58
GameChanger 2.0	38067 9	pure grey	shiny	275	L	57 - 61
GameChanger 2.0	40927 1	Movistar Team 24	shiny	260	S	51 - 55
GameChanger 2.0	94303 4	Movistar Team 24	shiny	265	M	54 - 58
GameChanger 2.0	38042 6	Movistar Team 24	shiny	275	L	57 - 61
GameChanger 2.0	97996 5	velvet black	matt+shiny	260	S	51 - 55
GameChanger 2.0	97997 2	velvet black	matt+shiny	265	M	54 - 58
GameChanger 2.0	97998 9	velvet black	matt+shiny	275	L	57 - 61
GameChanger 2.0	97999 6	titan	shiny	260	S	51 - 55
GameChanger 2.0	98000 8	titan	shiny	265	M	54 - 58
GameChanger 2.0	98001 5	titan	shiny	275	L	57 - 61
GameChanger 2.0	98002 2	race grey	shiny	260	S	51 - 55
GameChanger 2.0	98003 9	race grey	shiny	265	M	54 - 58
GameChanger 2.0	98004 6	race grey	shiny	275	L	57 - 61
GameChanger 2.0	98005 3	shiny white	shiny	260	S	51 - 55
GameChanger 2.0	98006 0	shiny white	shiny	265	M	54 - 58
GameChanger 2.0	98007 7	shiny white	shiny	275	L	57 - 61
GameChanger 2.0	98008 4	performance red	shiny	260	S	51 - 55
GameChanger 2.0	98009 1	performance red	shiny	265	M	54 - 58
GameChanger 2.0	98010 7	performance red	shiny	275	L	57 - 61
GameChanger 2.0	98011 4	flip flop purple	shiny	260	S	51 - 55
GameChanger 2.0	98012 1	flip flop purple	shiny	265	M	54 - 58
GameChanger 2.0	98013 8	flip flop purple	shiny	275	L	57 - 61
GameChanger 2.0	98014 5	goldfish orange	shiny	260	S	51 - 55
GameChanger 2.0	98015 2	goldfish orange	shiny	265	M	54 - 58
GameChanger 2.0	98016 9	goldfish orange	shiny	275	L	57 - 61
GameChanger 2.0	98017 6	gleam silver	matt+shiny	260	S	51 - 55
GameChanger 2.0	98018 3	gleam silver	matt+shiny	265	M	54 - 58
GameChanger 2.0	98019 0	gleam silver	matt+shiny	275	L	57 - 61
GameChanger 2.0	98020 6	moss green	shiny	260	S	51 - 55
GameChanger 2.0	98021 3	moss green	shiny	265	M	54 - 58
GameChanger 2.0	98028 2	moss green	shiny	275	L	57 - 61
GameChanger 2.0	98022 0	polar white	matt+shiny	260	S	51 - 55
GameChanger 2.0	98023 7	polar white	matt+shiny	265	M	54 - 58
GameChanger 2.0	98024 4	polar white	matt+shiny	275	L	57 - 61
GameChanger 2.0	98025 1	black gold	matt+shiny	260	S	51 - 55
GameChanger 2.0	98026 8	black gold	matt+shiny	265	M	54 - 58
GameChanger 2.0	98027 5	black gold	matt+shiny	275	L	57 - 61
GameChanger 2.0 MIPS	98029 9	velvet black	matt+shiny	260	S	51 - 55
GameChanger 2.0 MIPS	98030 5	velvet black	matt+shiny	275	M	54 - 58
GameChanger 2.0 MIPS	98031 2	velvet black	matt+shiny	285	L	57 - 61
GameChanger 2.0 MIPS	98032 9	shiny white	shiny	260	S	51 - 55
GameChanger 2.0 MIPS	98033 6	shiny white	shiny	275	M	54 - 58
GameChanger 2.0 MIPS	98034 3	shiny white	shiny	285	L	57 - 61
GameChanger 2.0 MIPS	98035 0	performance red	shiny	260	S	51 - 55
GameChanger 2.0 MIPS	98036 7	performance red	shiny	275	M	54 - 58
GameChanger 2.0 MIPS	98037 4	performance red	shiny	285	L	57 - 61
GameChanger 2.0 MIPS	98038 1	flip flop purple	shiny	260	S	51 - 55
GameChanger 2.0 MIPS	98039 8	flip flop purple	shiny	275	M	54 - 58
GameChanger 2.0 MIPS	98040 4	flip flop purple	shiny	285	L	57 - 61
Race Cap	96047 5	autumn black			M/L	56 - 61
Race Cap	96048 2	porto blue			M/L	56 - 61
Race Cap	96049 9	italian white			M/L	56 - 61
Race Cap	96046 8	adventure blue			M/L	56 - 61
ABUS Bag	78592 4	black			universal	
Helmet bag sportiv	68451 7	black			universal	

STORMCHASER ACE

VIEWS



pure mint



pure mint



FEATURES



Zoom Ace



FlowStraps



Eyewaer Port



TECHNOLOGY



VERSIONS



pure grey



pure white



velvet black



race grey



performance red



flip flop purple



polar white

Ref. No.	EAN 4003318	Colour	Finish	Weight g	Size	Head size cm
StormChaser ACE	38069 3	pure mint	matt+shiny	200	S	51 - 55
StormChaser ACE	94328 7	pure mint	matt+shiny	220	M	54 - 58
StormChaser ACE	40954 7	pure mint	matt+shiny	240	L	57 - 61
StormChaser ACE	94329 4	pure grey	shiny	200	S	51 - 55
StormChaser ACE	40955 4	pure grey	shiny	220	M	54 - 58
StormChaser ACE	40437 5	pure grey	shiny	240	L	57 - 61
StormChaser ACE	40436 8	pure white	shiny	200	S	51 - 55
StormChaser ACE	38068 6	pure white	shiny	220	M	54 - 58
StormChaser ACE	94327 0	pure white	shiny	240	L	57 - 61
StormChaser ACE	98041 1	velvet black	matt	200	S	51 - 55
StormChaser ACE	98042 8	velvet black	matt	220	M	54 - 58
StormChaser ACE	98043 5	velvet black	matt	240	L	57 - 61
StormChaser ACE	98044 2	race grey	shiny	200	S	51 - 55
StormChaser ACE	98045 9	race grey	shiny	220	M	54 - 58
StormChaser ACE	98046 6	race grey	shiny	240	L	57 - 61
StormChaser ACE	98047 3	performance red	shiny	200	S	51 - 55
StormChaser ACE	98048 0	performance red	shiny	220	M	54 - 58
StormChaser ACE	98049 7	performance red	shiny	240	L	57 - 61
StormChaser ACE	98050 3	flip flop purple	shiny	200	S	51 - 55
StormChaser ACE	98051 0	flip flop purple	shiny	220	M	54 - 58
StormChaser ACE	98052 7	flip flop purple	shiny	240	L	57 - 61
StormChaser ACE	98053 4	polar white	matt	200	S	51 - 55
StormChaser ACE	98054 1	polar white	matt	220	M	54 - 58
StormChaser ACE	98055 8	polar white	matt	240	L	57 - 61
Race Cap	96047 5	autumn black			M/L	56 - 61
Race Cap	96048 2	porto blue			M/L	56 - 61
Race Cap	96049 9	italian white			M/L	56 - 61
Race Cap	96046 8	adventure blue			M/L	56 - 61
ABUS Bag	78592 4	black			universal	
Helmet bag sportiv	68451 7	black			universal	



POWERDOME ACE

VIEWS



moss green



moss green



FEATURES



Zoom Ace



Buckle



FlowStraps

TECHNOLOGY



VERSIONS



race grey



metallic copper

Ref. No.	EAN 4003318	Colour	Finish	Weight g	Size	Head size cm
PowerDome ACE	91973 2	moss green	shiny	210	S	51 - 55
PowerDome ACE	91974 9	moss green	shiny	230	M	54 - 58
PowerDome ACE	91975 6	moss green	shiny	250	L	57 - 61
PowerDome ACE	91970 1	race grey	shiny	210	S	51 - 55
PowerDome ACE	91971 8	race grey	shiny	230	M	54 - 58
PowerDome ACE	91972 5	race grey	shiny	250	L	57 - 61
PowerDome ACE	91976 3	metallic copper	matt	210	S	51 - 55
PowerDome ACE	91977 0	metallic copper	matt	230	M	54 - 58
PowerDome ACE	91978 7	metallic copper	matt	250	L	57 - 61
Race Cap	96047 5	autumn black			M/L	56 - 61
Race Cap	96048 2	porto blue			M/L	56 - 61
Race Cap	96049 9	italian white			M/L	56 - 61
Race Cap	96046 8	adventure blue			M/L	56 - 61
ABUS Bag	78592 4	black			universal	



POWERDOME

VIEWS



gleam silver



gleam silver



FEATURES



Zoom Ace



Buckle



FlowStraps

TECHNOLOGY



VERSIONS



polar white



velvet black



shiny black



titan



shiny white



goldfish orange



blaze red



flip flop purple



gleam silver



polar white



velvet black



shiny black



titan



shiny white



goldfish orange



blaze red



flip flop purple

Ref. No.	EAN 4003318	Colour	Finish	Weight g	Size	Head size cm
PowerDome	97989 7	gleam silver	matt+shiny	210	S	51 - 55
PowerDome	97990 3	gleam silver	matt+shiny	230	M	54 - 58
PowerDome	97991 0	gleam silver	matt+shiny	250	L	57 - 61
PowerDome	98243 9	polar white	matt	210	S	51 - 55
PowerDome	98244 6	polar white	matt	230	M	54 - 58
PowerDome	98246 0	polar white	matt	250	L	57 - 61
PowerDome	91920 6	velvet black	matt	210	S	51 - 55
PowerDome	91921 3	velvet black	matt	230	M	54 - 58
PowerDome	91922 0	velvet black	matt	250	L	57 - 61
PowerDome	91923 7	shiny black	shiny	210	S	51 - 55
PowerDome	91924 4	shiny black	shiny	230	M	54 - 58
PowerDome	91925 1	shiny black	shiny	250	L	57 - 61
PowerDome	91926 8	titan	shiny	210	S	51 - 55
PowerDome	91927 5	titan	shiny	230	M	54 - 58
PowerDome	91928 2	titan	shiny	250	L	57 - 61
PowerDome	91929 9	shiny white	shiny	210	S	51 - 55
PowerDome	91930 5	shiny white	shiny	230	M	54 - 58
PowerDome	91934 3	shiny white	shiny	250	L	57 - 61
PowerDome	91940 4	goldfish orange	shiny	210	S	51 - 55
PowerDome	91941 1	goldfish orange	shiny	230	M	54 - 58
PowerDome	91942 8	goldfish orange	shiny	250	L	57 - 61
PowerDome	91943 5	blaze red	shiny	210	S	51 - 55
PowerDome	91944 2	blaze red	shiny	230	M	54 - 58
PowerDome	91945 9	blaze red	shiny	250	L	57 - 61
PowerDome	91946 6	flip flop purple	shiny	210	S	51 - 55
PowerDome	91947 3	flip flop purple	shiny	230	M	54 - 58
PowerDome	91948 0	flip flop purple	shiny	250	L	57 - 61
PowerDome MIPS	97992 7	gleam silver	matt+shiny	240	S	51 - 55
PowerDome MIPS	97993 4	gleam silver	matt+shiny	260	M	54 - 58
PowerDome MIPS	97994 1	gleam silver	matt+shiny	280	L	57 - 61
PowerDome MIPS	98248 4	polar white	matt	240	S	51 - 55
PowerDome MIPS	98249 1	polar white	matt	260	M	54 - 58
PowerDome MIPS	98250 7	polar white	matt	280	L	57 - 61
PowerDome MIPS	91949 7	velvet black	matt	240	S	51 - 55
PowerDome MIPS	91950 3	velvet black	matt	260	M	54 - 58
PowerDome MIPS	91951 0	velvet black	matt	280	L	57 - 61
PowerDome MIPS	91952 7	shiny black	shiny	240	S	51 - 55
PowerDome MIPS	91953 4	shiny black	shiny	260	M	54 - 58
PowerDome MIPS	91954 1	shiny black	shiny	280	L	57 - 61
PowerDome MIPS	91955 8	titan	shiny	240	S	51 - 55
PowerDome MIPS	91956 5	titan	shiny	260	M	54 - 58
PowerDome MIPS	91957 2	titan	shiny	280	L	57 - 61
PowerDome MIPS	91958 9	shiny white	shiny	240	S	51 - 55
PowerDome MIPS	91959 6	shiny white	shiny	260	M	54 - 58
PowerDome MIPS	91960 2	shiny white	shiny	280	L	57 - 61
PowerDome MIPS	91961 9	goldfish orange	shiny	240	S	51 - 55
PowerDome MIPS	91962 6	goldfish orange	shiny	260	M	54 - 58
PowerDome MIPS	91963 3	goldfish orange	shiny	280	L	57 - 61
PowerDome MIPS	91964 0	blaze red	shiny	240	S	51 - 55
PowerDome MIPS	91965 7	blaze red	shiny	260	M	54 - 58
PowerDome MIPS	91966 4	blaze red	shiny	280	L	57 - 61
PowerDome MIPS	91967 1	flip flop purple	shiny	240	S	51 - 55
PowerDome MIPS	91968 8	flip flop purple	shiny	260	M	54 - 58
PowerDome MIPS	91969 5	flip flop purple	shiny	280	L	57 - 61
Race Cap	96047 5	autumn black			M/L	56 - 61
Race Cap	96048 2	porto blue			M/L	56 - 61
Race Cap	96049 9	italian white			M/L	56 - 61
Race Cap	96046 8	adventure blue			M/L	56 - 61
ABUS Bag	78592 4	black			universal	

WINGBACK

VIEWS



flip flop purple



flip flop purple



FEATURES



Zoom Ace



Buckle



FlowStraps

TECHNOLOGY



VERSIONS



velvet black



titan



race grey



shiny white



performance red



goldfish orange



gleam silver



moss green



polar white

Ref. No.	EAN 4003318	Colour	Finish	Weight g	Size	Head size cm
WingBack	98071 8	flip flop purple	shiny	230	S	51 - 55
WingBack	98072 5	flip flop purple	shiny	240	M	54 - 58
WingBack	98073 2	flip flop purple	shiny	270	L	57 - 61
WingBack	98056 5	velvet black	matt	230	S	51 - 55
WingBack	98057 2	velvet black	matt	240	M	54 - 58
WingBack	98058 9	velvet black	matt	270	L	57 - 61
WingBack	98059 6	titan	shiny	230	S	51 - 55
WingBack	98060 2	titan	shiny	240	M	54 - 58
WingBack	98061 9	titan	shiny	270	L	57 - 61
WingBack	98062 6	race grey	shiny	230	S	51 - 55
WingBack	98063 3	race grey	shiny	240	M	54 - 58
WingBack	98064 0	race grey	shiny	270	L	57 - 61
WingBack	98065 7	shiny white	shiny	230	S	51 - 55
WingBack	98066 4	shiny white	shiny	240	M	54 - 58
WingBack	98067 1	shiny white	shiny	270	L	57 - 61
WingBack	98068 8	performance red	shiny	230	S	51 - 55
WingBack	98069 5	performance red	shiny	240	M	54 - 58
WingBack	98070 1	performance red	shiny	270	L	57 - 61
WingBack	98074 9	goldfish orange	shiny	230	S	51 - 55
WingBack	98075 6	goldfish orange	shiny	240	M	54 - 58
WingBack	98076 3	goldfish orange	shiny	270	L	57 - 61
WingBack	98077 0	gleam silver	shiny	230	S	51 - 55
WingBack	98078 7	gleam silver	shiny	240	M	54 - 58
WingBack	98079 4	gleam silver	shiny	270	L	57 - 61
WingBack	98080 0	moss green	shiny	230	S	51 - 55
WingBack	98081 7	moss green	shiny	240	M	54 - 58
WingBack	98082 4	moss green	shiny	270	L	57 - 61
WingBack	98083 1	polar white	matt	230	S	51 - 55
WingBack	98084 8	polar white	matt	240	M	54 - 58
WingBack	98085 5	polar white	matt	270	L	57 - 61



MACATOR

VIEWS



blaze red



blaze red



FEATURES



Zoom Ace



Buckle

TECHNOLOGY



VERSIONS



white silver



velvet black



steel blue



signal yellow



shiny rose



race grey



pearl white



midnight blue



gleam silver



matt black



matt blue



signal yellow



pearl white



shiny black

Ref. No.	EAN 4003318	Colour	Finish	Weight g	Size	Head size cm
Macator	87221 1	blaze red	shiny	280	S	51 - 55
Macator	87222 8	blaze red	shiny	300	M	52 - 58
Macator	87223 5	blaze red	shiny	360	L	58 - 62
Macator	87232 7	white silver	shiny	280	S	51 - 55
Macator	87233 4	white silver	shiny	300	M	52 - 58
Macator	87234 1	white silver	shiny	360	L	58 - 62
Macator	87214 3	velvet black	matt	280	S	51 - 55
Macator	87212 9	velvet black	matt	300	M	52 - 58
Macator	87213 6	velvet black	matt	360	L	58 - 62
Macator	87215 0	titan	shiny	280	S	51 - 55
Macator	87216 7	titan	shiny	300	M	52 - 58
Macator	87217 4	titan	shiny	360	L	58 - 62
Macator	87242 6	steel blue	shiny	280	S	51 - 55
Macator	87243 3	steel blue	shiny	300	M	52 - 58
Macator	87244 0	steel blue	shiny	360	L	58 - 62
Macator	87229 7	signal yellow	shiny	280	S	51 - 55
Macator	87230 3	signal yellow	shiny	300	M	52 - 58
Macator	87231 0	signal yellow	shiny	360	L	58 - 62
Macator	67334 4	shiny rose	shiny	280	S	51 - 55
Macator	67335 1	shiny rose	shiny	300	M	52 - 58
Macator	67336 8	shiny rose	shiny	360	L	58 - 62
Macator	67328 3	race grey	shiny	280	S	51 - 55
Macator	67329 0	race grey	shiny	300	M	52 - 58
Macator	67330 6	race grey	shiny	360	L	58 - 62
Macator	67331 3	pearl white	shiny	280	S	51 - 55
Macator	67332 0	pearl white	shiny	300	M	52 - 58
Macator	67333 7	pearl white	shiny	360	L	58 - 62
Macator	67325 2	midnight blue	shiny	280	S	51 - 55
Macator	67326 9	midnight blue	shiny	300	M	52 - 58
Macator	67327 6	midnight blue	shiny	360	L	58 - 62
Macator	87218 1	gleam silver	shiny	280	S	51 - 55
Macator	87219 8	gleam silver	shiny	300	M	52 - 58
Macator	87220 4	gleam silver	shiny	360	L	58 - 62
Macator	91183 5	matt black	matt	280	S	51 - 55
Macator	91184 2	matt black	matt	300	M	52 - 58
Macator	91185 9	matt black	matt	360	L	58 - 62
Macator	95591 4	matt blue	matt	280	S	51 - 55
Macator	95593 8	matt blue	matt	360	L	58 - 62
Macator MIPS	89220 2	signal yellow	shiny	370	L	58 - 62
Macator MIPS	89221 9	signal yellow	shiny	320	M	52 - 58
Macator MIPS	89222 6	signal yellow	shiny	290	S	51 - 55
Macator MIPS	96147 2	pearl white	shiny	290	M	52 - 58
Macator MIPS	96148 9	pearl white	shiny	310	L	58 - 62
Macator MIPS	96150 2	shiny black	shiny	290	M	52 - 58
Macator MIPS	96151 9	shiny black	shiny	310	L	58 - 62
Race Cap	96047 5	autumn black			M/L	56 - 61
Race Cap	96048 2	porto blue			M/L	56 - 61
Race Cap	96049 9	italian white			M/L	56 - 61
Race Cap	96046 8	adventure blue			M/L	56 - 61
ABUS Bag	78592 4	black			universal	

MTB



AIRDROP



Mips

concrete grey

Page 190



Mips

black gold

Page 190



Mips

polar white

Page 190



Mips

velvet black

Page 190

HIDROP



midnight blue

Page 192



shiny black

Page 192



shiny white

Page 192



moss green

Page 192

CLIFFHANGER



Ti silver

Page 194



concrete grey

Page 194



midnight blue

Page 194



pine green

Page 194



shiny white

Page 194



velvet black

Page 194



wildberry red

Page 194



Mips

metallic copper

Page 194



Mips

pine green

Page 194



Mips

shiny white

Page 194



Mips

concrete grey

Page 194



Mips

velvet black

Page 194

MOVENTOR 2.0



wildberry red

Page 196



concrete grey

Page 196



midnight blue

Page 196



pine green

Page 196



shiny white

Page 196



velvet black

Page 196



Ti silver

Page 196



metallic copper

Page 196



velvet black

Page 196



concrete grey

Page 196



pine green

Page 196



shiny white

Page 196

MODROP



pine green

Page 198



velvet black

Page 198



concrete grey

Page 198



midnight blue

Page 198



polar white

Page 198



wildberry red

Page 198



Ti silver

Page 198



velvet black

Page 198



concrete grey

Page 198



metallic copper

Page 198



shiny white

Page 198



pine green

Page 198



MOTRIP

shiny white

Page 200

shiny black

Page 200

midnight blue

Page 200

concrete grey

Page 200

shiny black

Page 200

shiny white

Page 200



mustard yellow

Page 202



pepper green

Page 202



pure white

Page 202



velvet black

Page 202

INDY



polar white

Page 204



infra red

Page 204



neon yellow

Page 204



velvet black

Page 204

BUTEO

AIRDROP

VIEWS



concrete grey



concrete grey



FEATURES



Zoom Ace FF



BreakAway Visor



Double D buckle



Collarbone Protection



ASC (Ambient Sound Channel)

TECHNOLOGY



VERSIONS



Mips

black gold



Mips

polar white



Mips

velvet black

Ref. No.	EAN 4003318	Colour	Finish	Weight g	Size	Head size cm
AirDrop MIPS	66024 5	concrete grey	matt	790	S/M	52 - 58
AirDrop MIPS	66026 9	concrete grey	matt	890	L/XL	58 - 62
AirDrop MIPS	66254 6	black gold	matt	790	S/M	52 - 58
AirDrop MIPS	66255 3	black gold	matt	890	L/XL	58 - 62
AirDrop MIPS	66022 1	polar white	matt	790	S/M	52 - 58
AirDrop MIPS	66023 8	polar white	matt	890	L/XL	58 - 62
AirDrop MIPS	65800 6	velvet black	matt	790	S/M	52 - 58
AirDrop MIPS	66021 4	velvet black	matt	890	L/XL	58 - 62
Buteo infra red	68933 8	infra red		140	universal	
Buteo neon yellow	68932 1	neon yellow		140	universal	
Buteo polar white	68931 4	polar white		140	universal	
Buteo velvet black	68930 7	velvet black		140	universal	



HIDROP

VIEWS



midnight blue



midnight blue



FEATURES



Double D buckle



BreakAway Visor



Visit our
campaign website

TECHNOLOGY



VERSIONS



shiny black



shiny white



moss green

Ref. No.	EAN 4003318	Colour	Finish	Weight g	Size	Head size cm
HiDrop	98103 6	midnight blue	shiny	1090	S	55 - 56
HiDrop	98104 3	midnight blue	shiny	1070	M	57 - 58
HiDrop	98105 0	midnight blue	shiny	1050	L	59 - 60
HiDrop	98106 7	midnight blue	shiny	1040	XL	61 - 62
HiDrop	98091 6	shiny black	shiny	1090	S	55 - 56
HiDrop	98092 3	shiny black	shiny	1070	M	57 - 58
HiDrop	98093 0	shiny black	shiny	1050	L	59 - 60
HiDrop	98094 7	shiny black	shiny	1040	XL	61 - 62
HiDrop	98095 4	shiny white	shiny	1090	S	55 - 56
HiDrop	98096 1	shiny white	shiny	1070	M	57 - 58
HiDrop	98097 8	shiny white	shiny	1050	L	59 - 60
HiDrop	98098 5	shiny white	shiny	1040	XL	61 - 62
HiDrop	98099 2	moss green	shiny	1090	S	55 - 56
HiDrop	98100 5	moss green	shiny	1070	M	57 - 58
HiDrop	98101 2	moss green	shiny	1050	L	59 - 60
HiDrop	98102 9	moss green	shiny	1040	XL	61 - 62
Buteo infra red	68933 8	infra red		140	universal	
Buteo neon yellow	68932 1	neon yellow		140	universal	
Buteo polar white	68931 4	polar white		140	universal	
Buteo velvet black	68930 7	velvet black		140	universal	

MTB



CLIFFHANGER

VIEWS



Ti silver



Ti silver



FEATURES



Zoom Ace MTB



Fidlock



TriVider



GoggFit



Height adjustable Visor

TECHNOLOGY



VERSIONS



concrete grey



midnight blue matt



pine green



shiny white



velvet black



wildberry red



Mips

metallic copper



Mips

pine green



Mips

shiny white



Mips

concrete grey



Mips

velvet black

Ref. No.	EAN 4003318	Colour	Finish	Weight g	Size	Head size cm
CliffHanger	67242 2	Ti silver	matt	300	S	51 - 55
CliffHanger	67243 9	Ti silver	matt	325	M	54 - 58
CliffHanger	67244 6	Ti silver	matt	365	L	57 - 61
CliffHanger	65539 5	concrete grey	matt	300	S	51 - 55
CliffHanger	65540 1	concrete grey	matt	325	M	54 - 58
CliffHanger	65541 8	concrete grey	matt	365	L	57 - 61
CliffHanger	65531 9	midnight blue	matt	300	S	51 - 55
CliffHanger	65532 6	midnight blue	matt	325	M	54 - 58
CliffHanger	65533 3	midnight blue	matt	365	L	57 - 61
CliffHanger	65534 0	pine green	matt	300	S	51 - 55
CliffHanger	65535 7	pine green	matt	325	M	54 - 58
CliffHanger	65536 4	pine green	matt	365	L	57 - 61
CliffHanger	65528 9	shiny white	shiny	300	S	51 - 55
CliffHanger	65529 6	shiny white	shiny	325	M	54 - 58
CliffHanger	65530 2	shiny white	shiny	365	L	57 - 61
CliffHanger	65525 8	velvet black	matt	300	S	51 - 55
CliffHanger	65526 5	velvet black	matt	325	M	54 - 58
CliffHanger	65527 2	velvet black	matt	365	L	57 - 61
CliffHanger	67239 2	wildberry red	matt	300	S	51 - 55
CliffHanger	67240 8	wildberry red	matt	325	M	54 - 58
CliffHanger	67241 5	wildberry red	matt	365	L	57 - 61
CliffHanger MIPS	65551 7	metallic copper	matt	330	S	51 - 55
CliffHanger MIPS	65552 4	metallic copper	matt	350	M	54 - 58
CliffHanger MIPS	65553 1	metallic copper	matt	390	L	57 - 61
CliffHanger MIPS	67248 4	pine green	matt	330	S	51 - 55
CliffHanger MIPS	67249 1	pine green	matt	350	M	54 - 58
CliffHanger MIPS	67306 1	pine green	matt	390	L	57 - 61
CliffHanger MIPS	67245 3	shiny white	shiny	330	S	51 - 55
CliffHanger MIPS	67246 0	shiny white	shiny	350	M	54 - 58
CliffHanger MIPS	67247 7	shiny white	shiny	390	L	57 - 61
CliffHanger MIPS	65554 8	concrete grey	matt	330	S	51 - 55
CliffHanger MIPS	66485 4	concrete grey	matt	350	M	54 - 58
CliffHanger MIPS	65555 5	concrete grey	matt	390	L	57 - 61
CliffHanger MIPS	65542 5	velvet black	matt	330	S	51 - 55
CliffHanger MIPS	65543 2	velvet black	matt	350	M	54 - 58
CliffHanger MIPS	65544 9	velvet black	matt	390	L	57 - 61

MTB



MOVENTOR 2.0

VIEWS



wildberry red



wildberry red



FEATURES



Zoom Ace MTB



Buckle



GoggFit



TriVider



Height adjustable Visor

TECHNOLOGY



VERSIONS



concrete grey



midnight blue



pine green



shiny white



velvet black



Ti silver



MIPS

metallic copper



MIPS

velvet black



MIPS

concrete grey



MIPS

pine green



MIPS

shiny white

Ref. No.	EAN 4003318	Colour	Finish	Weight g	Size	Head size cm
Moventor 2.0	83318 2	wildberry red	matt	290	S	51 - 55
Moventor 2.0	83319 9	wildberry red	matt	300	M	54 - 58
Moventor 2.0	83320 5	wildberry red	matt	320	L	57 - 61
Moventor 2.0	65502 9	concrete grey	matt	290	S	51 - 55
Moventor 2.0	65503 6	concrete grey	matt	300	M	54 - 58
Moventor 2.0	65504 3	concrete grey	matt	320	L	57 - 61
Moventor 2.0	65496 1	midnight blue	matt	290	S	51 - 55
Moventor 2.0	65497 8	midnight blue	matt	300	M	54 - 58
Moventor 2.0	65498 5	midnight blue	matt	320	L	57 - 61
Moventor 2.0	65499 2	pine green	matt	290	S	51 - 55
Moventor 2.0	65500 5	pine green	matt	300	M	54 - 58
Moventor 2.0	65501 2	pine green	matt	320	L	57 - 61
Moventor 2.0	65493 0	shiny white	shiny	290	S	51 - 55
Moventor 2.0	65494 7	shiny white	shiny	300	M	54 - 58
Moventor 2.0	65495 4	shiny white	shiny	320	L	57 - 61
Moventor 2.0	65490 9	velvet black	matt	290	S	51 - 55
Moventor 2.0	65491 6	velvet black	matt	300	M	54 - 58
Moventor 2.0	65492 3	velvet black	matt	320	L	57 - 61
Moventor 2.0	83321 2	Ti silver	matt	290	S	51 - 55
Moventor 2.0	84127 9	Ti silver	matt	300	M	54 - 58
Moventor 2.0	84250 4	Ti silver	matt	320	L	57 - 61
Moventor 2.0 MIPS	65511 1	metallic copper	shiny	320	S	51 - 55
Moventor 2.0 MIPS	65512 8	metallic copper	shiny	330	M	54 - 58
Moventor 2.0 MIPS	65513 5	metallic copper	shiny	350	L	51 - 61
Moventor 2.0 MIPS	65508 1	velvet black	matt	320	S	51 - 55
Moventor 2.0 MIPS	65509 8	velvet black	matt	330	M	54 - 58
Moventor 2.0 MIPS	65510 4	velvet black	matt	350	L	57 - 61
Moventor 2.0 MIPS	65514 2	concrete grey	shiny	320	S	51 - 55
Moventor 2.0 MIPS	65515 9	concrete grey	shiny	330	M	54 - 58
Moventor 2.0 MIPS	65516 6	concrete grey	shiny	350	L	57 - 61
Moventor 2.0 MIPS	87870 1	pine green	matt	320	S	51 - 55
Moventor 2.0 MIPS	88465 8	pine green	matt	330	M	54 - 58
Moventor 2.0 MIPS	88466 5	pine green	matt	350	L	57 - 61
Moventor 2.0 MIPS	84522 2	shiny white	matt	320	S	51 - 55
Moventor 2.0 MIPS	84523 9	shiny white	matt	330	M	54 - 58
Moventor 2.0 MIPS	85421 7	shiny white	matt	350	L	57 - 61
Padding fly net Moventor 2.0 S/M/L	91103 3					
ABUS Bag	78592 4	black			universal	

MTB



MODROP

VIEWS



pine green



pine green



FEATURES



Zoom Ace MTB



Buckle



TriVider



GoggFit



Height adjustable
Visor

TECHNOLOGY



VERSIONS



velvet black



concrete grey



midnight blue



polar white



wildberry red



Ti silver



MIPS
velvet black



MIPS

concrete grey



MIPS

metallic copper



MIPS

shiny white



MIPS

pine green

Ref. No.	EAN 4003318	Colour	Finish	Weight g	Size	Head size cm
MoDrop	64985 1	pine green	matt	310	S	51 - 55
MoDrop	64986 8	pine green	matt	330	M	54 - 58
MoDrop	64987 5	pine green	matt	360	L	57 - 61
MoDrop	64849 6	velvet black	matt	310	S	51 - 55
MoDrop	64851 9	velvet black	matt	330	M	54 - 58
MoDrop	64850 2	velvet black	matt	360	L	57 - 61
MoDrop	64852 6	concrete grey	matt	310	S	51 - 55
MoDrop	64853 3	concrete grey	matt	330	M	54 - 58
MoDrop	64854 0	concrete grey	matt	360	L	57 - 61
MoDrop	64861 8	midnight blue	matt	310	S	51 - 55
MoDrop	64863 2	midnight blue	matt	330	M	54 - 58
MoDrop	64871 7	midnight blue	matt	360	L	57 - 61
MoDrop	66475 5	polar white	matt	310	S	51 - 55
MoDrop	66476 2	polar white	matt	330	M	54 - 58
MoDrop	66477 9	polar white	matt	360	L	57 - 61
MoDrop	67601 7	wildberry red	matt	310	S	51 - 55
MoDrop	67612 3	wildberry red	matt	330	M	54 - 58
MoDrop	68077 9	wildberry red	matt	360	L	57 - 61
MoDrop	68981 9	Ti silver	matt	310	S	51 - 55
MoDrop	69056 3	Ti silver	matt	330	M	54 - 58
MoDrop	69079 2	Ti silver	matt	360	L	57 - 61
MoDrop MIPS	65739 9	velvet black	matt	340	S	51 - 55
MoDrop MIPS	65740 5	velvet black	matt	370	M	54 - 58
MoDrop MIPS	65741 2	velvet black	matt	390	L	57 - 61
MoDrop MIPS	65755 9	concrete grey	matt	340	S	51 - 55
MoDrop MIPS	65756 6	concrete grey	matt	370	M	54 - 58
MoDrop MIPS	65757 3	concrete grey	matt	390	L	57 - 61
MoDrop MIPS	65742 9	metallic copper	matt	340	S	51 - 55
MoDrop MIPS	65753 5	metallic copper	matt	370	M	54 - 58
MoDrop MIPS	65754 2	metallic copper	matt	390	L	57 - 61
MoDrop MIPS	69080 8	shiny white	shiny	340	S	51 - 55
MoDrop MIPS	69106 5	shiny white	shiny	370	M	54 - 58
MoDrop MIPS	69180 5	shiny white	shiny	390	L	57 - 61
MoDrop MIPS	69383 0	pine green	matt	340	S	51 - 55
MoDrop MIPS	69384 7	pine green	matt	370	M	54 - 58
MoDrop MIPS	72993 5	pine green	matt	390	L	57 - 61
Padding MoTrip/MoDrop black S/M/L	91096 8					
Padding fly net MoTrip S/M/L	91097 5					
ABUS Bag	78592 4	black			universal	

MTB



MOTRIP

VIEWS



shiny white



shiny white



FEATURES



Zoom Ace MTB



Buckle



GogFit



Height adjustable
Visor

TECHNOLOGY



VERSIONS



shiny black



midnight blue



concrete grey



shiny black



shiny white

Ref. No.	EAN 4003318	Colour	Finish	Weight g	Size	Head size cm
MoTrip	64712 3	shiny white	shiny	340	M	54 - 58
MoTrip	64710 9	shiny white	shiny	350	L	57 - 61
MoTrip	64706 2	shiny black	shiny	320	S	51 - 55
MoTrip	64707 9	shiny black	shiny	340	M	54 - 58
MoTrip	64708 6	shiny black	shiny	350	L	57 - 61
MoTrip	64711 6	midnight blue	shiny	320	S	51 - 55
MoTrip	64713 0	midnight blue	shiny	340	M	54 - 58
MoTrip	64714 7	midnight blue	shiny	350	L	57 - 61
MoTrip	64754 3	concrete grey	shiny	340	M	54 - 58
MoTrip	64847 2	concrete grey	shiny	350	L	57 - 61
MoTrip MIPS	88496 2	shiny black	shiny	350	S	51 - 55
MoTrip MIPS	88499 3	shiny black	shiny	370	M	54 - 58
MoTrip MIPS	88508 2	shiny black	shiny	380	L	57 - 61
MoTrip MIPS	88821 2	shiny white	shiny	350	S	51 - 55
MoTrip MIPS	89177 9	shiny white	shiny	380	L	57 - 61
MoTrip MIPS	88977 6	shiny white	shiny	370	M	54 - 58
Padding MoTrip/MoDrop black S/M/L	91096 8					
Padding fly net MoTrip S/M/L	91097 5					
ABUS Bag	78592 4	black			universal	

MTB



INDY

★
NEW

VIEWS



mustard yellow



mustard yellow



Based on athlete feedback, the adjustment is not carried out using a conventional adjustment system but via paddings.

FEATURES



Buckle

TECHNOLOGY



VERSIONS



pepper green



pure white



velvet black

Ref. No.	EAN 4003318	Colour	Finish	Weight g	Size	Head size cm
INDY	38049 5	mustard yellow	shiny	360	S	51 - 55
INDY	40418 4	mustard yellow	shiny	390	M	54 - 58
INDY	40935 6	mustard yellow	shiny	430	L	57 - 61
INDY	94310 2	pepper green	shiny	360	S	51 - 55
INDY	38050 1	pepper green	shiny	390	M	54 - 58
INDY	40419 1	pepper green	shiny	430	L	57 - 61
INDY	40417 7	pure white	matt	360	S	51 - 55
INDY	40934 9	pure white	matt	390	M	54 - 58
INDY	94309 6	pure white	matt	430	L	57 - 61
INDY	40933 2	velvet black	matt	360	S	51 - 55
INDY	94308 9	velvet black	matt	390	M	54 - 58
INDY	38048 8	velvet black	matt	430	L	57 - 61



BUTE0



TECHNICAL DATA

- Double layer glass to prevent fogging
- 40 mm strap for slip-free fit
- Fleece layer for maximum comfort
- Nose guard for a comfortable and secure fit
- Available with clear and mirrored tinted lenses

VERSIONS



infra red

neon yellow

velvet black

Ref. No.	EAN 4003318	Colour	Finish	Weight g	Size	Head size cm
Buteo infra red	68933 8	infra red		140	universal	
Buteo neon yellow	68932 1	neon yellow		140	universal	
Buteo polar white	68931 4	polar white		140	universal	
Buteo velvet black	68930 7	velvet black		140	universal	
Spare glass Buteos	68934 5	clear		15	universal	
Spare glass Buteos	68935 2	smoke		15	universal	
Spare glass Buteos	68936 9	red chrome		15	universal	
Spare glass Buteos	68937 6	black chrome		15	universal	



MTB

URBAN



HYP-E BL.ACE



volcano titan

Page 214



gleam silver

Page 214

HYP-E ACE



gleam silver

Page 216



volcano titan

Page 216

HYP-E



jungle green

Page 218



champagne gold

Page 218



volcano titan

Page 218



gleam silver

Page 218

PEDELEC 2.0 ACE



champagne gold

Page 220



velvet black

Page 220



signal yellow

Page 220



pearl white

Page 220



midnight blue

Page 220



race grey

Page 220



titan

Page 220



blaze red

Page 220

PEDELEC 2.0



race grey

Page 222



velvet black

Page 222



signal yellow

Page 222



pearl white

Page 222



midnight blue

Page 222



titan

Page 222



champagne gold

Page 222



blaze red

Page 222



Mips velvet black

Page 222



Mips signal yellow

Page 222



Mips silver edition

Page 222

HUD-Y ACE



pure aqua

Page 224



pure mint

Page 224



pure lavender

Page 224



pure rose

Page 224



pure white

Page 224



champange gold

Page 224



gleam silver

Page 224



iced blue

Page 224



moss green

Page 224



shiny white

Page 224



goldfish orange

Page 224



velvet black

Page 224



pure mint

Page 226



pure aqua

Page 226



pure lavender

Page 226



pure rose

Page 226



pure white

Page 226



puristic

Page 226



metallic copper

Page 226



moss green

Page 226



iced blue

Page 226



gleam silver

Page 226



velvet black

Page 226



titan

Page 226



signal yellow

Page 226



race grey

Page 226



champagne gold

Page 226



shiny white

Page 226



goldfish orange

Page 226



flower white

Page 226



midnight blue

Page 226

HUD-Y

URBAN-I 3.0 ACE



gleam silver

Page 228



moss green

Page 228



iced blue

Page 228



velvet black

Page 228



goldfish orange

Page 228



polar white

Page 228



metallic copper

Page 228

URBAN-I 3.0



velvet black

Page 230



titan

Page 230



street art

Page 230



polar white

Page 230



living coral

Page 230



jade green

Page 230



glacier blue

Page 230



flower art

Page 230



core green

Page 230



core blue

Page 230



signal yellow

Page 230



signal silver

Page 230



signal orange

Page 230



Mips

velvet black

Page 230



Mips

titan

Page 230



Mips

signal yellow

Page 230

PURL-Y ACE



mint green

Page 232



light lavender

Page 232



velvet black

Page 232



titan

Page 232



polar white

Page 232



metallic copper

Page 232



midnight blue

Page 232



moss green

Page 232



champagne gold

Page 232



iced blue

Page 232



signal yellow

Page 232



light lavender

Page 234



mint green

Page 234



shiny black

Page 234



titan

Page 234



shiny white

Page 234



metallic copper

Page 234

PURL-Y



midnight blue

Page 234



moss green

Page 234



champagne gold

Page 234



iced blue

Page 234



signal yellow

Page 234



signal black

Page 236



signal yellow

Page 236



signal silver

Page 236



titan

Page 238



velvet black

Page 238



signal yellow

Page 238



polar white

Page 238

HYBAN 2.0 LED

HYBAN 2.0 ACE

HYBAN 2.0



chrome silver

Page 240



velvet black

Page 240



titan

Page 240



polar white

Page 240



glacier blue

Page 240



core green

Page 240



core blue

Page 240



chrome rosé

Page 240



signal silver

Page 240



signal yellow

Page 240



velvet black

Page 240



titan

Page 240



signal yellow

Page 240

XOXO



mint green

Page 242



aqua blue

Page 242



polar white

Page 242



velvet black

Page 242



birch taupe

Page 244

XOXO ECO

SKURB ACE



goldfish orange

Page 246



moss green

Page 246



velvet black

Page 246



silver white

Page 246

SKURB



goldfish orange

Page 248



moss green

Page 248



velvet black

Page 248



titan

Page 248



pearl white

Page 248



midnight blue

Page 248

ADURO 3.0 LED



velvet black

Page 250



polar white

Page 250



midnight blue

Page 250



titan

Page 250



race black

Page 250



glacier blue

Page 250



blaze red

Page 250



race grey

Page 250



maori
blackberry

Page 250



white art

Page 250



orange palm

Page 250



purple waves

Page 250



signal yellow

Page 250

ADURO 3.0



purple waves

Page 252



velvet black

Page 252



polar white

Page 252



midnight blue

Page 252



titan

Page 252



race black

Page 252



glacier blue

Page 252



blaze red

Page 252



race grey

Page 252



maori
blackberry

Page 252



white art

Page 252



orange palm

Page 252



signal yellow

Page 252



HYP- E BL.ACE

VIEWS



volcano titan



volcano titan



FEATURES



Remote Control Brake Light



Remote Control Indicator Light



Visor magnetic



Earpads



Vent Cover

TECHNOLOGY



VERSIONS



gleam silver

Ref. No.	EAN 4003318	Colour	Finish	Weight g	Size	Head size cm
HYP-E BL.ACE	38060 0	volcano titan	matt+shiny	685	S	51 - 55
HYP-E BL.ACE	94319 5	volcano titan	matt+shiny	715	M	54 - 58
HYP-E BL.ACE	40945 5	volcano titan	matt+shiny	745	L	57 - 61
HYP-E BL.ACE	94320 1	gleam silver	matt+shiny	685	S	51 - 55
HYP-E BL.ACE	40946 2	gleam silver	matt+shiny	715	M	54 - 58
HYP-E BL.ACE	40428 3	gleam silver	matt+shiny	745	L	57 - 61
EarPads	40430 6	black			universal	
Visier clear	40947 9	clear			S/M	
Visier clear	94563 2	clear			L	
Visier smoke	94321 8	smoke			S/M	
Visier smoke	41168 7	smoke			L	
Visier photochromic	38062 4	photochromic			S/M	
Visier photochromic	38276 5	photochromic			L	
Remote Control Indicator Light	38061 7	black			universal	
Remote Control Brake Light	40429 0	black			universal	



HYP- E ACE

VIEWS



gleam silver



gleam silver



FEATURES



Remote Control Indicator Light



Magnetic visor



Earpads



Vent Cover



TECHNOLOGY



VERSIONS



volcano titan

Ref. No.	EAN 4003318	Colour	Finish	Weight g	Size	Head size cm
HYP-E ACE	40427 6	gleam silver	matt+shiny	685	S	51 - 55
HYP-E ACE	38059 4	gleam silver	matt+shiny	715	M	54 - 58
HYP-E ACE	94318 8	gleam silver	matt+shiny	745	L	57 - 61
HYP-E ACE	40944 8	volcano titan	matt+shiny	685	S	51 - 55
HYP-E ACE	40426 9	volcano titan	matt+shiny	715	M	54 - 58
HYP-E ACE	38058 7	volcano titan	matt+shiny	745	L	57 - 61
EarPads	40430 6	black			universal	
Visier clear	40947 9	clear			S/M	
Visier clear	94563 2	clear			L	
Visier smoke	94321 8	smoke			S/M	
Visier smoke	41168 7	smoke			L	
Visier photochromic	38062 4	photochromic			S/M	
Visier photochromic	38276 5	photochromic			L	
Remote Control Indicator Light	38061 7	black			universal	
Remote Control Brake Light	40429 0	black			universal	



HYP- E

VIEWS



jungle green



jungle green



FEATURES



Remote Control Indicator Light



Vent Cover



TECHNOLOGY



VERSIONS



champagne gold



volcano titan



gleam silver

Ref. No.	EAN 4003318	Colour	Finish	Weight g	Size	Head size cm
HYP-E	40942 4	jungle green	matt+shiny	550	S	51 - 55
HYP-E	40425 2	jungle green	matt+shiny	580	M	54 - 58
HYP-E	38056 3	jungle green	matt+shiny	610	L	57 - 61
HYP-E	40943 1	champagne gold	matt+shiny	550	S	51 - 55
HYP-E	38057 0	champagne gold	matt+shiny	580	M	54 - 58
HYP-E	94317 1	champagne gold	matt+shiny	610	L	57 - 61
HYP-E	38055 6	volcano titan	matt+shiny	550	S	51 - 55
HYP-E	94315 7	volcano titan	matt+shiny	580	M	54 - 58
HYP-E	40940 0	volcano titan	matt+shiny	610	L	57 - 61
HYP-E	94316 4	gleam silver	matt+shiny	550	S	51 - 55
HYP-E	40941 7	gleam silver	matt+shiny	580	M	54 - 58
HYP-E	40424 5	gleam silver	matt+shiny	610	L	57 - 61
EarPads	40430 6	black			universal	
Visier clear	40947 9	clear			S/M	
Visier clear	94563 2	clear			L	
Visier smoke	94321 8	smoke			S/M	
Visier smoke	41168 7	smoke			L	
Visier photochromic	38062 4	photochromic			S/M	
Visier photochromic	38276 5	photochromic			L	
Remote Control Indicator Light	38061 7	black			universal	
Remote Control Brake Light	40429 0	black			universal	



PEDELEC 2.0 ACE

VIEWS



champagne gold



champagne gold



FEATURES



Zoom Ace Urban



Fidlock



GlowStraps



USB-light



Raincap

TECHNOLOGY



NTA 8776

VERSIONS



velvet black



signal yellow



pearl white



midnight blue



race grey



titan



blaze red

Ref. No.	EAN 4003318	Colour	Finish	Weight g	Size	Head size cm
Pedelec 2.0 ACE	91912 1	champagne gold	shiny	390	S	51 - 55
Pedelec 2.0 ACE	91913 8	champagne gold	shiny	410	M	52 - 57
Pedelec 2.0 ACE	91914 5	champagne gold	shiny	430	L	56 - 62
Pedelec 2.0 ACE	66732 9	velvet black	matt	390	S	51 - 55
Pedelec 2.0 ACE	81925 4	velvet black	matt	410	M	52 - 57
Pedelec 2.0 ACE	81929 2	velvet black	matt	430	L	56 - 62
Pedelec 2.0 ACE	66735 0	signal yellow	shiny	390	S	51 - 55
Pedelec 2.0 ACE	81928 5	signal yellow	shiny	410	M	52 - 57
Pedelec 2.0 ACE	81932 2	signal yellow	shiny	430	L	56 - 62
Pedelec 2.0 ACE	67337 5	pearl white	shiny	390	S	51 - 55
Pedelec 2.0 ACE	67338 2	pearl white	shiny	410	M	52 - 57
Pedelec 2.0 ACE	67339 9	pearl white	shiny	430	L	56 - 62
Pedelec 2.0 ACE	66736 7	midnight blue	matt	390	S	51 - 55
Pedelec 2.0 ACE	81927 8	midnight blue	matt	410	M	52 - 57
Pedelec 2.0 ACE	81931 5	midnight blue	matt	430	L	56 - 62
Pedelec 2.0 ACE	91909 1	race grey	shiny	390	S	51 - 55
Pedelec 2.0 ACE	91910 7	race grey	shiny	410	M	52 - 57
Pedelec 2.0 ACE	91911 4	race grey	shiny	430	L	56 - 62
Pedelec 2.0 ACE	91906 0	titan	matt	390	S	51 - 55
Pedelec 2.0 ACE	91907 7	titan	matt	410	M	52 - 57
Pedelec 2.0 ACE	91908 4	titan	matt	430	L	56 - 62
Pedelec 2.0 ACE	91917 6	blaze red	shiny	390	S	51 - 55
Pedelec 2.0 ACE	91918 3	blaze red	shiny	410	M	52 - 57
Pedelec 2.0 ACE	91919 0	blaze red	shiny	430	L	56 - 62
Visor smoke Pedelec 2.0, Hyban 2.0, HUD-Y	82888 1	smoke			universal	
Visor clear Pedelec 2.0, Hyban 2.0, HUD-Y	82889 8	clear			universal	



PEDELEC 2.0

VIEWS



race grey



race grey



FEATURES



Zoom Ace Urban



Fidlock



GlowStraps



USB-light



Raincap

TECHNOLOGY



VERSIONS



velvet black



signal yellow



pearl white



midnight blue



titan



champagne gold



blaze red



Mips

velvet black



Mips

signal yellow



Mips

silver edition

Ref. No.	EAN 4003318	Colour	Finish	Weight g	Size	Head size cm
Pedelec 2.0	91897 1	race grey	shiny	330	S	51 - 55
Pedelec 2.0	91898 8	race grey	shiny	350	M	52 - 57
Pedelec 2.0	91899 5	race grey	shiny	370	L	56 - 62
Pedelec 2.0	40597 6	velvet black	matt	330	S	51 - 55
Pedelec 2.0	81919 3	velvet black	matt	350	M	52 - 57
Pedelec 2.0	81913 1	velvet black	matt	370	L	56 - 62
Pedelec 2.0	40595 2	signal yellow	shiny	330	S	51 - 55
Pedelec 2.0	81922 3	signal yellow	shiny	350	M	52 - 57
Pedelec 2.0	81916 2	signal yellow	shiny	370	L	56 - 62
Pedelec 2.0	40593 8	pearl white	shiny	330	S	51 - 55
Pedelec 2.0	40188 6	pearl white	shiny	350	M	52 - 57
Pedelec 2.0	40189 3	pearl white	shiny	370	L	56 - 62
Pedelec 2.0	40297 5	midnight blue	matt	330	S	51 - 55
Pedelec 2.0	81921 6	midnight blue	matt	350	M	52 - 57
Pedelec 2.0	81915 5	midnight blue	matt	370	L	56 - 62
Pedelec 2.0	91894 0	titan	matt	330	S	51 - 55
Pedelec 2.0	91895 7	titan	matt	350	M	52 - 57
Pedelec 2.0	91896 4	titan	matt	370	L	56 - 62
Pedelec 2.0	91900 8	champagne gold	shiny	330	S	51 - 55
Pedelec 2.0	91901 5	champagne gold	shiny	350	M	52 - 57
Pedelec 2.0	91902 2	champagne gold	shiny	370	L	56 - 62
Pedelec 2.0	91903 9	blaze red	shiny	330	S	51 - 55
Pedelec 2.0	91904 6	blaze red	shiny	350	M	52 - 57
Pedelec 2.0	91905 3	blaze red	shiny	370	L	56 - 62
Pedelec 2.0 MIPS	89193 9	velvet black	matt	390	L	56 - 62
Pedelec 2.0 MIPS	89194 6	velvet black	matt	370	M	52 - 57
Pedelec 2.0 MIPS	89197 7	signal yellow	shiny	390	L	56 - 62
Pedelec 2.0 MIPS	89198 4	signal yellow	shiny	370	M	52 - 57
Pedelec 2.0 MIPS	89195 3	silver edition	matt	390	L	56 - 62
Pedelec 2.0 MIPS	89196 0	silver edition	matt	370	M	52 - 57
Earpads Pedelec 2.0 black	83482 0	black			universal	
Visor smoke Pedelec 2.0, Hyban 2.0, HUD-Y	82888 1	smoke			universal	
Visor clear Pedelec 2.0, Hyban 2.0, HUD-Y	82889 8	clear			universal	

Urban



HUD-Y ACE

VIEWS



pure aqua



pure aqua



FEATURES



Magnetic USB tail light



Zoom Evo Adult



Fidlock



Buckle (Pure Edition)

TECHNOLOGY



VERSIONS



pure mint

pure lavender

pure rose

pure white

champagne gold

gleam silver

iced blue



moss green

shiny white

goldfish orange

velvet black

Ref. No.	EAN 4003318	Colour	Finish	Weight g	Size	Head size cm
HUD-Y ACE	40343 9	pure aqua	matt+shiny	400	S	51 - 55
HUD-Y ACE	38028 0	pure aqua	matt+shiny	430	M	54 - 58
HUD-Y ACE	94289 1	pure aqua	matt+shiny	460	L	57 - 61
HUD-Y ACE	38026 6	pure mint	matt+shiny	400	S	51 - 55
HUD-Y ACE	94287 7	pure mint	matt+shiny	430	M	54 - 58
HUD-Y ACE	40911 0	pure mint	matt+shiny	460	L	57 - 61
HUD-Y ACE	94288 4	pure lavender	matt+shiny	400	S	51 - 55
HUD-Y ACE	40912 7	pure lavender	matt+shiny	430	M	54 - 58
HUD-Y ACE	40341 5	pure lavender	matt+shiny	460	L	57 - 61
HUD-Y ACE	40913 4	pure rose	matt+shiny	400	S	51 - 55
HUD-Y ACE	40342 2	pure rose	matt+shiny	430	M	54 - 58
HUD-Y ACE	38027 3	pure rose	matt+shiny	460	L	57 - 61
HUD-Y ACE	94286 0	pure white	matt+shiny	460	L	57 - 61
HUD-Y ACE	40340 8	pure white	matt+shiny	400	S	51 - 55
HUD-Y ACE	38025 9	pure white	matt+shiny	430	M	54 - 58
HUD-Y ACE	99168 4	champange gold	matt	400	S	51 - 55
HUD-Y ACE	99169 1	champange gold	matt	430	M	54 - 58
HUD-Y ACE	99170 7	champange gold	matt	460	L	57 - 61
HUD-Y ACE	99165 3	gleam silver	shiny	400	S	51 - 55
HUD-Y ACE	99166 0	gleam silver	shiny	430	M	54 - 58
HUD-Y ACE	99167 7	gleam silver	shiny	460	L	57 - 61
HUD-Y ACE	99162 2	iced blue	shiny	400	S	51 - 55
HUD-Y ACE	99163 9	iced blue	shiny	430	M	54 - 58
HUD-Y ACE	99164 6	iced blue	shiny	460	L	57 - 61
HUD-Y ACE	99160 8	moss green	shiny	430	M	54 - 58
HUD-Y ACE	99161 5	moss green	shiny	460	L	57 - 61
HUD-Y ACE	99159 2	moss green	shiny	400	S	51 - 55
HUD-Y ACE	91995 4	shiny white	shiny	400	S	51 - 55
HUD-Y ACE	91996 1	shiny white	shiny	430	M	54 - 58
HUD-Y ACE	91997 8	shiny white	shiny	460	L	57 - 61
HUD-Y ACE	91998 5	goldfish orange	shiny	400	S	51 - 55
HUD-Y ACE	91999 2	goldfish orange	shiny	430	M	54 - 58
HUD-Y ACE	04486 1	goldfish orange	shiny	460	L	57 - 61
HUD-Y ACE	91992 3	velvet black	matt	400	S	51 - 55
HUD-Y ACE	91993 0	velvet black	matt	430	M	54 - 58
HUD-Y ACE	91994 7	velvet black	matt	460	L	57 - 61
Visor smoke Pedelec 2.0, Hyban 2.0, HUD-Y	82888 1	smoke				universal
Visor clear Pedelec 2.0, Hyban 2.0, HUD-Y	82889 8	clear				universal
Fastening visor Pedelec 2.0, Hyban 2.0, HUD-Y	82890 4					universal
ABUS Bag	78592 4	black				universal

Urban



HUD-Y

NEW

VIEWS



pure mint



pure mint



FEATURES



Magnetic USB tail light



Zoom Evo Adult



Fidlock



Buckle (Pure Edition)



Flipflop Visor

TECHNOLOGY



VERSIONS



pure aqua



pure lavender



pure rose



pure white



puristic



metallic copper



moss green



iced blue



gleam silver



velvet black



titan



signal yellow



race grey



champagne gold



shiny white



goldfish orange



flower white



midnight blue

Ref. No.	EAN 4003318	Colour	Finish	Weight g	Size	Head size cm
HUD-Y	90949 8	pure mint	matt+shiny	280	S	51 - 55
HUD-Y	90948 1	pure mint	matt+shiny	300	M	54 - 58
HUD-Y	90947 4	pure mint	matt+shiny	330	L	57 - 61
HUD-Y	40910 3	pure aqua	matt+shiny	280	S	51 - 55
HUD-Y	40339 2	pure aqua	matt+shiny	300	M	54 - 58
HUD-Y	38024 2	pure aqua	matt+shiny	330	L	57 - 61
HUD-Y	38023 5	pure lavender	matt+shiny	280	S	51 - 55
HUD-Y	94284 6	pure lavender	matt+shiny	300	M	54 - 58
HUD-Y	90952 8	pure lavender	matt+shiny	330	L	57 - 61
HUD-Y	94285 3	pure rose	matt+shiny	280	S	51 - 55
HUD-Y	40909 7	pure rose	matt+shiny	300	M	54 - 58
HUD-Y	40338 5	pure rose	matt+shiny	330	L	57 - 61
HUD-Y	90946 7	pure white	matt+shiny	280	S	51 - 55
HUD-Y	90944 3	pure white	matt+shiny	300	M	54 - 58
HUD-Y	40908 0	pure white	matt+shiny	330	L	57 - 61
HUD-Y	38063 1	puristic	shiny	280	S	51 - 55
HUD-Y	94322 5	puristic	shiny	300	M	54 - 58
HUD-Y	40948 6	puristic	shiny	330	L	57 - 61
HUD-Y	97932 3	metallic copper	matt	280	S	51 - 55
HUD-Y	97934 7	metallic copper	matt	300	M	54 - 58
HUD-Y	97935 4	metallic copper	matt	330	L	57 - 61
HUD-Y	97936 1	moss green	shiny	280	S	51 - 55
HUD-Y	97937 8	moss green	shiny	300	M	54 - 58
HUD-Y	97938 5	moss green	shiny	330	L	57 - 61
HUD-Y	97939 2	iced blue	shiny	280	S	51 - 55
HUD-Y	97940 8	iced blue	shiny	300	M	54 - 58
HUD-Y	97941 5	iced blue	shiny	330	L	57 - 61
HUD-Y	97942 2	gleam silver	shiny	280	S	51 - 55
HUD-Y	97943 9	gleam silver	shiny	300	M	54 - 58
HUD-Y	97944 6	gleam silver	shiny	330	L	57 - 61
HUD-Y	91979 4	velvet black	matt	280	S	51 - 55
HUD-Y	66843 2	velvet black	matt	300	M	54 - 58
HUD-Y	66844 9	velvet black	matt	330	L	57 - 61
HUD-Y	91980 0	titan	matt	280	S	51 - 55
HUD-Y	66947 7	titan	matt	300	M	54 - 58
HUD-Y	67038 1	titan	matt	330	L	57 - 61
HUD-Y	91983 1	signal yellow	shiny	280	S	51 - 55
HUD-Y	67043 5	signal yellow	shiny	300	M	54 - 58
HUD-Y	67044 2	signal yellow	shiny	330	L	57 - 61
HUD-Y	91985 5	race grey	shiny	280	S	51 - 55
HUD-Y	67934 6	race grey	shiny	300	M	54 - 58
HUD-Y	67935 3	race grey	shiny	330	L	57 - 61
HUD-Y	91984 8	champagne gold	matt	280	S	51 - 55
HUD-Y	67039 8	champagne gold	matt	300	M	54 - 58
HUD-Y	67040 4	champagne gold	matt	330	L	57 - 61
HUD-Y	91986 2	shiny white	shiny	280	S	51 - 55
HUD-Y	91987 9	shiny white	shiny	300	M	54 - 58
HUD-Y	91988 6	shiny white	shiny	330	L	57 - 61
HUD-Y	91989 3	goldfish orange	shiny	280	S	51 - 55
HUD-Y	91990 9	goldfish orange	shiny	300	M	54 - 58
HUD-Y	66945 3	flower white	shiny	330	L	57 - 61
HUD-Y	66944 6	flower white	shiny	300	M	54 - 58
HUD-Y	67042 8	midnight blue	matt	330	L	57 - 61
HUD-Y	67041 1	midnight blue	matt	300	M	54 - 58
HUD-Y	91981 7	flower white	shiny	280	S	51 - 55
HUD-Y	91982 4	midnight blue	matt	280	S	51 - 55
HUD-Y	91991 6	goldfish orange	shiny	330	L	57 - 61
ABUS Bag	78592 4	black			universal	

URBAN-I 3.0 ACE

VIEWS



gleam silver



gleam silver



FEATURES



Zoom Ace Urban



Fidlock



LED



TriVider

TECHNOLOGY



VERSIONS



moss green



iced blue



velvet black



goldfish orange



polar white



metallic copper

Ref. No.	EAN 4003318	Colour	Finish	Weight g	Size	Head size cm
Urban-I 3.0 ACE	97954 5	gleam silver	shiny	250	S	51 - 55
Urban-I 3.0 ACE	97955 2	gleam silver	shiny	280	M	52 - 58
Urban-I 3.0 ACE	97956 9	gleam silver	shiny	300	L	56 - 61
Urban-I 3.0 ACE	97948 4	moss green	shiny	250	S	51 - 55
Urban-I 3.0 ACE	97949 1	moss green	shiny	280	M	52 - 58
Urban-I 3.0 ACE	97950 7	moss green	shiny	300	L	56 - 61
Urban-I 3.0 ACE	97951 4	iced blue	shiny	250	S	51 - 55
Urban-I 3.0 ACE	97952 1	iced blue	shiny	280	M	52 - 58
Urban-I 3.0 ACE	97953 8	iced blue	shiny	300	L	56 - 61
Urban-I 3.0 ACE	02940 0	velvet black	matt	250	S	51 - 55
Urban-I 3.0 ACE	02999 8	velvet black	matt	280	M	52 - 58
Urban-I 3.0 ACE	03244 8	velvet black	matt	300	L	56 - 61
Urban-I 3.0 ACE	03413 8	goldfish orange	shiny	250	S	51 - 55
Urban-I 3.0 ACE	03414 5	goldfish orange	shiny	280	M	52 - 58
Urban-I 3.0 ACE	03415 2	goldfish orange	shiny	300	L	56 - 61
Urban-I 3.0 ACE	03410 7	polar white	matt	250	S	51 - 55
Urban-I 3.0 ACE	03411 4	polar white	matt	280	M	52 - 58
Urban-I 3.0 ACE	03412 1	polar white	matt	300	L	56 - 61
Urban-I 3.0 ACE	03416 9	metallic copper	matt	250	S	51 - 55
Urban-I 3.0 ACE	03417 6	metallic copper	matt	280	M	52 - 58
Urban-I 3.0 ACE	03418 3	metallic copper	matt	300	L	56 - 61
ABUS Bag	78592 4	black			universal	



URBAN-I 3.0

VIEWS



velvet black



velvet black



FEATURES



Zoom Ace Urban



Fidlock



LED

TECHNOLOGY



VERSIONS



titan



street art



polar white



living coral



jade green



glacier blue



flower art



core green



core blue



signal yellow



signal silver



signal orange



velvet black



titan



signal yellow

Ref. No.	EAN 4003318	Colour	Finish	Weight g	Size	Head size cm
Urban-I 3.0	86857 3	velvet black	matt	250	S	51 - 55
Urban-I 3.0	86851 1	velvet black	matt	280	M	52 - 58
Urban-I 3.0	86852 8	velvet black	matt	300	L	56 - 61
Urban-I 3.0	86853 5	velvet black	matt	325	XL	61 - 65
Urban-I 3.0	86862 7	titan	matt	250	S	51 - 55
Urban-I 3.0	86863 4	titan	matt	280	M	52 - 58
Urban-I 3.0	86864 1	titan	matt	300	L	56 - 61
Urban-I 3.0	86865 8	titan	matt	325	XL	61 - 65
Urban-I 3.0	40192 3	street art	matt+shiny	250	S	51 - 55
Urban-I 3.0	40193 0	street art	matt+shiny	280	M	52 - 58
Urban-I 3.0	40194 7	street art	matt+shiny	300	L	56 - 61
Urban-I 3.0	40195 4	street art	matt+shiny	325	XL	61 - 65
Urban-I 3.0	86858 0	polar white	matt	250	S	51 - 55
Urban-I 3.0	86859 7	polar white	matt	280	M	52 - 58
Urban-I 3.0	86860 3	polar white	matt	300	L	56 - 61
Urban-I 3.0	86861 0	polar white	matt	325	XL	61 - 65
Urban-I 3.0	86897 9	living coral	matt	250	S	51 - 55
Urban-I 3.0	86898 6	living coral	matt	280	M	52 - 58
Urban-I 3.0	88639 3	living coral	matt	300	L	56 - 61
Urban-I 3.0	86891 7	jade green	matt	250	S	51 - 55
Urban-I 3.0	86894 8	glacier blue	matt	250	S	51 - 55
Urban-I 3.0	86895 5	glacier blue	matt	280	M	52 - 58
Urban-I 3.0	86896 2	glacier blue	matt	300	L	56 - 61
Urban-I 3.0	40190 9	flower art	matt+shiny	250	S	51 - 55
Urban-I 3.0	40191 6	flower art	matt+shiny	280	M	52 - 58
Urban-I 3.0	64214 2	flower art	matt+shiny	300	L	56 - 61
Urban-I 3.0	86882 5	core green	matt	250	S	51 - 55
Urban-I 3.0	86883 2	core green	matt	280	M	52 - 58
Urban-I 3.0	86884 9	core green	matt	300	L	56 - 61
Urban-I 3.0	86885 6	core green	matt	325	XL	61 - 65
Urban-I 3.0	86878 8	core blue	matt	250	S	51 - 55
Urban-I 3.0	86879 5	core blue	matt	280	M	52 - 58
Urban-I 3.0	86880 1	core blue	matt	300	L	56 - 61
Urban-I 3.0	86881 8	core blue	matt	325	XL	61 - 65
Urban-I 3.0	86866 5	signal yellow	shiny	250	S	51 - 55
Urban-I 3.0	86867 2	signal yellow	shiny	280	M	52 - 58
Urban-I 3.0	86868 9	signal yellow	shiny	300	L	56 - 61
Urban-I 3.0	86869 6	signal yellow	shiny	325	XL	61 - 65
Urban-I 3.0	86874 0	signal silver	shiny	250	S	51 - 55
Urban-I 3.0	86875 7	signal silver	shiny	280	M	52 - 58
Urban-I 3.0	86876 4	signal silver	shiny	300	L	56 - 61
Urban-I 3.0	86877 1	signal silver	shiny	325	XL	61 - 65
Urban-I 3.0	86870 2	signal orange	shiny	250	S	51 - 55
Urban-I 3.0	86871 9	signal orange	shiny	280	M	52 - 58
Urban-I 3.0 MIPS	89184 7	velvet black	matt	270	S	51 - 55
Urban-I 3.0 MIPS	89183 0	velvet black	matt	300	M	52 - 58
Urban-I 3.0 MIPS	89182 3	velvet black	matt	320	L	56 - 61
Urban-I 3.0 MIPS	89181 6	velvet black	matt	345	XL	61 - 65
Urban-I 3.0 MIPS	89187 8	titan	matt	270	S	51 - 55
Urban-I 3.0 MIPS	89186 1	titan	matt	300	M	52 - 58
Urban-I 3.0 MIPS	89185 4	titan	matt	320	L	56 - 61
Urban-I 3.0 MIPS	89188 5	titan	matt	345	XL	61 - 65
Urban-I 3.0 MIPS	89191 5	signal yellow	shiny	270	S	51 - 55
Urban-I 3.0 MIPS	89190 8	signal yellow	shiny	300	M	52 - 58
Urban-I 3.0 MIPS	89189 2	signal yellow	shiny	320	L	56 - 61
Urban-I 3.0 MIPS	89192 2	signal yellow	shiny	345	XL	61 - 65
ABUS Bag	78592 4	black			universal	

PURL-Y ACE

VIEWS



mint green



mint green



FEATURES



Zoom Ace Urban



Buckle



Magnetic USB tail light



TECHNOLOGY



VERSIONS



light lavender

velvet black

titan

polar white

metallic copper

midnight blue

moss green



champagne gold



iced blue



signal yellow

Ref. No.	EAN 4003318	Colour	Finish	Weight g	Size	Head size cm
PURL-Y ACE	38078 5	mint green	matt+shiny	320	S	51 - 55
PURL-Y ACE	94337 9	mint green	matt+shiny	340	M	54 - 58
PURL-Y ACE	40963 9	mint green	matt+shiny	360	L	57 - 61
PURL-Y ACE	94338 6	light lavender	matt+shiny	320	S	51 - 55
PURL-Y ACE	40964 6	light lavender	matt+shiny	340	M	54 - 58
PURL-Y ACE	40446 7	light lavender	matt+shiny	360	L	57 - 61
PURL-Y ACE	97904 0	velvet black	matt+shiny	320	S	51 - 55
PURL-Y ACE	97905 7	velvet black	matt+shiny	340	M	54 - 58
PURL-Y ACE	97906 4	velvet black	matt+shiny	360	L	57 - 61
PURL-Y ACE	97907 1	titan	matt+shiny	320	S	51 - 55
PURL-Y ACE	97908 8	titan	matt+shiny	340	M	54 - 58
PURL-Y ACE	97909 5	titan	matt+shiny	360	L	57 - 61
PURL-Y ACE	97910 1	polar white	matt+shiny	320	S	51 - 55
PURL-Y ACE	97912 5	polar white	matt+shiny	340	M	54 - 58
PURL-Y ACE	97913 2	polar white	matt+shiny	360	L	57 - 61
PURL-Y ACE	97914 9	metallic copper	matt+shiny	320	S	51 - 55
PURL-Y ACE	97915 6	metallic copper	matt+shiny	340	M	54 - 58
PURL-Y ACE	97916 3	metallic copper	matt+shiny	360	L	57 - 61
PURL-Y ACE	97917 0	midnight blue	matt+shiny	320	S	51 - 55
PURL-Y ACE	97918 7	midnight blue	matt+shiny	340	M	54 - 58
PURL-Y ACE	97919 4	midnight blue	matt+shiny	360	L	57 - 61
PURL-Y ACE	97920 0	moss green	matt+shiny	320	S	51 - 55
PURL-Y ACE	97921 7	moss green	matt+shiny	340	M	54 - 58
PURL-Y ACE	97922 4	moss green	matt+shiny	360	L	57 - 61
PURL-Y ACE	97926 2	champagne gold	matt+shiny	320	S	51 - 55
PURL-Y ACE	97927 9	champagne gold	matt+shiny	340	M	54 - 58
PURL-Y ACE	97928 6	champagne gold	matt+shiny	360	L	57 - 61
PURL-Y ACE	97923 1	iced blue	matt+shiny	320	S	51 - 55
PURL-Y ACE	97924 8	iced blue	matt+shiny	340	M	54 - 58
PURL-Y ACE	97925 5	iced blue	matt+shiny	360	L	57 - 61
PURL-Y ACE	97929 3	signal yellow	matt+shiny	320	S	51 - 55
PURL-Y ACE	97930 9	signal yellow	matt+shiny	340	M	54 - 58
PURL-Y ACE	97931 6	signal yellow	matt+shiny	360	L	57 - 61
ABUS Bag	78592 4	black			universal	

Urban



PURL-Y

NEW

VIEWS



light lavender



light lavender



FEATURES



Zoom Ace Urban



Buckle



Magnetic USB tail light (optional)



TECHNOLOGY



NTA 8776

VERSIONS



mint green



shiny black



titan



shiny white



metallic copper



midnight blue



moss green



champagne gold



iced blue



signal yellow

Ref. No.	EAN 4003318	Colour	Finish	Weight g	Size	Head size cm
PURL-Y	40445 0	light lavender	matt+shiny	300	S	51 - 55
PURL-Y	38077 8	light lavender	matt+shiny	320	M	54 - 58
PURL-Y	94336 2	light lavender	matt+shiny	340	L	57 - 61
PURL-Y	40962 2	mint green	matt+shiny	300	S	51 - 55
PURL-Y	40444 3	mint green	matt+shiny	320	M	54 - 58
PURL-Y	38076 1	mint green	matt+shiny	340	L	57 - 61
PURL-Y	97850 0	shiny black	shiny	300	S	51 - 55
PURL-Y	97878 4	shiny black	shiny	320	M	54 - 58
PURL-Y	97879 1	shiny black	shiny	340	L	57 - 61
PURL-Y	97880 7	titan	shiny	300	S	51 - 55
PURL-Y	97881 4	titan	shiny	320	M	54 - 58
PURL-Y	97882 1	titan	shiny	340	L	57 - 61
PURL-Y	97883 8	shiny white	shiny	300	S	51 - 55
PURL-Y	97884 5	shiny white	shiny	320	M	54 - 58
PURL-Y	97885 2	shiny white	shiny	340	L	57 - 61
PURL-Y	97886 9	metallic copper	shiny	300	S	51 - 55
PURL-Y	97887 6	metallic copper	shiny	320	M	54 - 58
PURL-Y	97888 3	metallic copper	shiny	340	L	57 - 61
PURL-Y	97889 0	midnight blue	shiny	300	S	51 - 55
PURL-Y	97890 6	midnight blue	shiny	320	M	54 - 58
PURL-Y	97891 3	midnight blue	shiny	340	L	57 - 61
PURL-Y	97892 0	moss green	shiny	300	S	51 - 55
PURL-Y	97893 7	moss green	shiny	320	M	54 - 58
PURL-Y	97894 4	moss green	shiny	340	L	57 - 61
PURL-Y	97898 2	champagne gold	shiny	300	S	51 - 55
PURL-Y	97899 9	champagne gold	shiny	320	M	54 - 58
PURL-Y	97900 2	champagne gold	shiny	340	L	57 - 61
PURL-Y	97895 1	iced blue	shiny	300	S	51 - 55
PURL-Y	97896 8	iced blue	shiny	320	M	54 - 58
PURL-Y	97897 5	iced blue	shiny	340	L	57 - 61
PURL-Y	97901 9	signal yellow	shiny	300	S	51 - 55
PURL-Y	97902 6	signal yellow	shiny	320	M	54 - 58
PURL-Y	97903 3	signal yellow	shiny	340	L	57 - 61
Spare light USB HUD-Y (ACE) / PURL-Y (ACE)	69446 2	black				
ABUS Bag	78592 4	black			universal	

Urban



HYBAN 2.0 LED

VIEWS



signal black



signal black



FEATURES



Zoom Ace Urban



Buckle



USB LED 360

TECHNOLOGY



VERSIONS



signal yellow



signal silver

Ref. No.	EAN 4003318	Colour	Finish	Weight g	Size	Head size cm
Hyban 2.0 LED	61458 3	signal black	matt	400	M	52 - 58
Hyban 2.0 LED	61459 0	signal black	matt	455	L	56 - 61
Hyban 2.0 LED	61460 6	signal black	matt	500	XL	58 - 63
Hyban 2.0 LED	61461 3	signal yellow	shiny	400	M	52 - 58
Hyban 2.0 LED	61462 0	signal yellow	shiny	455	L	56 - 61
Hyban 2.0 LED	61463 7	signal yellow	shiny	500	XL	58 - 63
Hyban 2.0 LED	61464 4	signal silver	shiny	400	M	52 - 58
Hyban 2.0 LED	61465 1	signal silver	shiny	455	L	56 - 61
Hyban 2.0 LED	61466 8	signal silver	shiny	500	XL	58 - 63
ABUS Bag	78592 4	black			universal	



HYBAN 2.0 ACE

VIEWS



titan



titan



FEATURES



Zoom Ace Urban



Fidlock



LED

TECHNOLOGY



VERSIONS



velvet black



signal yellow



polar white

Ref. No.	EAN 4003318	Colour	Finish	Weight g	Size	Head size cm
Hyban 2.0 ACE	86937 2	titan	matt	470	M	52 - 58
Hyban 2.0 ACE	86938 9	titan	matt	510	L	56 - 61
Hyban 2.0 ACE	86939 6	titan	matt	560	XL	58 - 63
Hyban 2.0 ACE	86934 1	velvet black	matt	470	M	52 - 58
Hyban 2.0 ACE	86935 8	velvet black	matt	510	L	56 - 61
Hyban 2.0 ACE	86936 5	velvet black	matt	560	XL	58 - 63
Hyban 2.0 ACE	86940 2	signal yellow	shiny	470	M	52 - 58
Hyban 2.0 ACE	86941 9	signal yellow	shiny	510	L	56 - 61
Hyban 2.0 ACE	86997 6	polar white	shiny	470	M	52 - 58
Hyban 2.0 ACE	86998 3	polar white	shiny	510	L	56 - 61
Visor smoke Pedelec 2.0, Hyban 2.0, HUD-Y	82888 1	smoke			universal	
Visor clear Pedelec 2.0, Hyban 2.0, HUD-Y	82889 8	clear			universal	
ABUS Bag	78592 4	black			universal	



HYBAN 2.0

VIEWS



chrome silver



chrome silver



FEATURES



Zoom Ace Urban



Buckle



LED

TECHNOLOGY



VERSIONS



velvet black

titan

polar white

glacier blue

core green

core blue

chrome rosé



signal silver



signal yellow



MIPS

velvet black



MIPS

titan



MIPS

signal yellow

Ref. No.	EAN 4003318	Colour	Finish	Weight g	Size	Head size cm
Hyban 2.0	40184 8	chrome silver	shiny	400	M	52 - 58
Hyban 2.0	40197 8	chrome silver	shiny	460	L	56 - 61
Hyban 2.0	86899 3	velvet black	matt	400	M	52 - 58
Hyban 2.0	86900 6	velvet black	matt	460	L	56 - 61
Hyban 2.0	86901 3	velvet black	matt	500	XL	58 - 63
Hyban 2.0	86905 1	titan	matt	400	M	52 - 58
Hyban 2.0	86906 8	titan	matt	460	L	56 - 61
Hyban 2.0	86907 5	titan	matt	500	XL	58 - 63
Hyban 2.0	86902 0	polar white	shiny	400	M	52 - 58
Hyban 2.0	86903 7	polar white	shiny	460	L	56 - 61
Hyban 2.0	86904 4	polar white	shiny	500	XL	58 - 63
Hyban 2.0	86929 7	glacier blue	shiny	400	M	52 - 58
Hyban 2.0	86930 3	glacier blue	shiny	460	L	56 - 61
Hyban 2.0	86920 4	core green	shiny	400	M	52 - 58
Hyban 2.0	86921 1	core green	shiny	460	L	56 - 61
Hyban 2.0	86917 4	core blue	shiny	400	M	52 - 58
Hyban 2.0	86918 1	core blue	shiny	460	L	56 - 61
Hyban 2.0	40185 5	chrome rosé	shiny	400	M	52 - 58
Hyban 2.0	86914 3	signal silver	shiny	400	M	52 - 58
Hyban 2.0	86915 0	signal silver	shiny	460	L	56 - 61
Hyban 2.0	86916 7	signal silver	shiny	480	XL	58 - 63
Hyban 2.0	86908 2	signal yellow	shiny	400	M	52 - 58
Hyban 2.0	86909 9	signal yellow	shiny	460	L	56 - 61
Hyban 2.0 MIPS	89200 4	velvet black	matt	420	M	52 - 58
Hyban 2.0 MIPS	89199 1	velvet black	matt	480	L	56 - 61
Hyban 2.0 MIPS	89203 5	titan	matt	420	M	52 - 58
Hyban 2.0 MIPS	89202 8	titan	matt	480	L	56 - 61
Hyban 2.0 MIPS	89204 2	titan	matt	500	XL	58 - 63
Hyban 2.0 MIPS	89206 6	signal yellow	shiny	420	M	52 - 58
Hyban 2.0 MIPS	89205 9	signal yellow	shiny	480	L	56 - 61
Hyban 2.0 MIPS	89207 3	signal yellow	shiny	500	XL	58 - 63
ABUS Bag	78592 4	black			universal	

Urban



XOXO

★
NEW

VIEWS



mint green



mint green



FEATURES



Zoom SLD



Buckle

TECHNOLOGY



VERSIONS



aqua blue



polar white



velvet black

Ref. No.	EAN 4003318	Colour	Finish	Weight g	Size	Head size cm
XOXO	38052 5	mint green	matt	370	S	51 - 55
XOXO	40421 4	mint green	matt	400	M	54 - 58
XOXO	40938 7	mint green	matt	440	L	57 - 61
XOXO	94313 3	aqua blue	matt	370	S	51 - 55
XOXO	38053 2	aqua blue	matt	400	M	54 - 58
XOXO	40422 1	aqua blue	matt	440	L	57 - 61
XOXO	40420 7	polar white	matt	370	S	51 - 55
XOXO	40937 0	polar white	matt	400	M	54 - 58
XOXO	94312 6	polar white	matt	440	L	57 - 61
XOXO	40936 3	velvet black	matt	370	S	51 - 55
XOXO	94311 9	velvet black	matt	400	M	54 - 58
XOXO	38051 8	velvet black	matt	440	L	57 - 61



XOXO ECO

★
NEW

VIEWS



birch taupe



birch taupe



FEATURES



Zoom SLD



Buckle

XOXO ECO –
the city helmet for
urban commuters.
Made from recycled
materials*, it makes a
bold statement for
sustainable
mobility.

TECHNOLOGY



*EPS core and straps are 100 % recycled materials. ABS shell 20 % recycled, Adjustment system: 30 %, pads: 84 % recycled lycra + 100 % recycled velvet + non recycled PU foam. The connecting points are not glued or riveted.

Ref. No.	EAN 4003318	Colour	Finish	Weight g	Size	Head size cm
XOXO ECO	38156 0	birch taupe	matt	370	S	51 - 55
XOXO ECO	94423 9	birch taupe	matt	400	M	54 - 58
XOXO ECO	41040 6	birch taupe	matt	440	L	57 - 61



Urban

SKURB ACE

VIEWS



goldfish orange



goldfish orange



FEATURES



Zoom Ace MTB



Buckle

TECHNOLOGY



VERSIONS



moss green



velvet black



silver white

Ref. No.	EAN 4003318	Colour	Finish	Weight g	Size	Head size cm
Skurb ACE	97963 7	goldfish orange	shiny	300	S	52 - 56
Skurb ACE	97964 4	goldfish orange	shiny	310	M	55 - 59
Skurb ACE	97965 1	goldfish orange	shiny	340	L	58 - 61
Skurb ACE	97967 5	moss green	shiny	300	S	52 - 56
Skurb ACE	97968 2	moss green	shiny	310	M	55 - 59
Skurb ACE	97969 9	moss green	shiny	340	L	58 - 61
Skurb ACE	40385 9	velvet black	matt+shiny	310	S	52 - 56
Skurb ACE	40386 6	velvet black	matt+shiny	320	M	55 - 59
Skurb ACE	40387 3	velvet black	matt+shiny	340	L	58 - 61
Skurb ACE	40394 1	silver white	matt+shiny	310	S	52 - 56
Skurb ACE	40395 8	silver white	matt+shiny	320	M	55 - 59
Skurb ACE	40396 5	silver white	matt+shiny	340	L	58 - 61



SKURB

VIEWS



goldfish orange



goldfish orange



FEATURES



Zoom Ace MTB



Buckle

TECHNOLOGY



VERSIONS



moss green



velvet black



titan



pearl white



midnight blue

Ref. No.	EAN 4003318	Colour	Finish	Weight g	Size	Head size cm
Skurb	97957 6	goldfish orange	shiny	300	S	52 - 56
Skurb	97958 3	goldfish orange	shiny	310	M	55 - 59
Skurb	97959 0	goldfish orange	shiny	340	L	58 - 61
Skurb	97960 6	moss green	shiny	300	S	52 - 56
Skurb	97961 3	moss green	shiny	310	M	55 - 59
Skurb	97962 0	moss green	shiny	340	L	58 - 61
Skurb	40367 5	velvet black	matt	300	S	52 - 56
Skurb	40368 2	velvet black	matt	310	M	55 - 59
Skurb	40369 9	velvet black	matt	340	L	58 - 61
Skurb	40370 5	titan	matt	300	S	52 - 56
Skurb	40371 2	titan	matt	310	M	55 - 59
Skurb	40372 9	titan	matt	340	L	58 - 61
Skurb	40373 6	pearl white	shiny	300	S	52 - 56
Skurb	40374 3	pearl white	shiny	310	M	55 - 59
Skurb	40375 0	pearl white	shiny	340	L	58 - 61
Skurb	40376 7	midnight blue	shiny	300	S	52 - 56
Skurb	40377 4	midnight blue	shiny	310	M	55 - 59
Skurb	40378 1	midnight blue	shiny	340	L	58 - 61



ADURO 3.0 LED

VIEWS



velvet black



FEATURES



Zoom Ace



Buckle



USB tail light incl.

TECHNOLOGY



VERSIONS



polar white



midnight blue



titan



race black



glacier blue



blaze red



race grey



maori blackberry



white art



orange palm



purple waves



signal yellow

Ref. No.	EAN 4003318	Colour	Finish	Weight g	Size	Head size cm
Aduro 3.0 LED	94637 0	velvet black	matt	295	S	51 - 55
Aduro 3.0 LED	41242 4	velvet black	matt	315	M	52 - 58
Aduro 3.0 LED	38348 9	velvet black	matt	335	L	58 - 62
Aduro 3.0 LED	38354 0	polar white	matt	295	S	51 - 55
Aduro 3.0 LED	41249 3	polar white	matt	315	M	52 - 58
Aduro 3.0 LED	94644 8	polar white	matt	335	L	58 - 62
Aduro 3.0 LED	38356 4	midnight blue	shiny	295	S	51 - 55
Aduro 3.0 LED	41251 6	midnight blue	shiny	315	M	52 - 58
Aduro 3.0 LED	94646 2	midnight blue	shiny	335	L	58 - 62
Aduro 3.0 LED	41244 8	titan	matt	295	S	51 - 55
Aduro 3.0 LED	94639 4	titan	matt	315	M	52 - 58
Aduro 3.0 LED	38350 2	titan	matt	335	L	58 - 62
Aduro 3.0 LED	41247 9	race black	matt	295	S	51 - 55
Aduro 3.0 LED	41255 4	race black	matt	315	M	52 - 58
Aduro 3.0 LED	94642 4	race black	matt	335	L	58 - 62
Aduro 3.0 LED	38358 8	glacier blue	shiny	295	S	51 - 55
Aduro 3.0 LED	41253 0	glacier blue	shiny	315	M	52 - 58
Aduro 3.0 LED	38359 5	glacier blue	shiny	335	L	58 - 62
Aduro 3.0 LED	41254 7	blaze red	shiny	295	S	51 - 55
Aduro 3.0 LED	94648 6	blaze red	shiny	315	M	52 - 58
Aduro 3.0 LED	38360 1	blaze red	shiny	335	L	58 - 62
Aduro 3.0 LED	41246 2	race grey	matt	295	S	51 - 55
Aduro 3.0 LED	94641 7	race grey	matt	315	M	52 - 58
Aduro 3.0 LED	38352 6	race grey	matt	335	L	58 - 62
Aduro 3.0 LED	38357 1	maori blackberry	matt	295	S	51 - 55
Aduro 3.0 LED	41252 3	maori blackberry	matt	315	M	52 - 58
Aduro 3.0 LED	94647 9	maori blackberry	matt	335	L	58 - 62
Aduro 3.0 LED	41243 1	white art	shiny	295	S	51 - 55
Aduro 3.0 LED	94638 7	white art	shiny	315	M	52 - 58
Aduro 3.0 LED	38349 6	white art	shiny	335	L	58 - 62
Aduro 3.0 LED	38355 7	orange palm	shiny	295	S	51 - 55
Aduro 3.0 LED	41250 9	orange palm	shiny	315	M	52 - 58
Aduro 3.0 LED	94645 5	orange palm	shiny	335	L	58 - 62
Aduro 3.0 LED	38353 3	purple waves	shiny	295	S	51 - 55
Aduro 3.0 LED	41248 6	purple waves	shiny	315	M	52 - 58
Aduro 3.0 LED	94643 1	purple waves	shiny	335	L	58 - 62
Aduro 3.0 LED	41245 5	signal yellow	shiny	295	S	51 - 55
Aduro 3.0 LED	94640 0	signal yellow	shiny	315	M	52 - 58
Aduro 3.0 LED	38351 9	signal yellow	shiny	335	L	58 - 62
USB light Aduro 3.0	02939 4	Aduro 3.0				
ABUS Bag	78592 4	black			universal	

Urban



ADURO 3.0

VIEWS



purple waves



purple waves



FEATURES



Zoom Ace



Buckle



USB tail light
(optional)

TECHNOLOGY



VERSIONS



velvet black



polar white



midnight blue



titan



race black



glacier blue



blaze red



race grey



maori blackberry



white art



orange palm



signal yellow

Ref. No.	EAN 4003318	Colour	Finish	Weight g	Size	Head size cm
Aduro 3.0	02098 8	purple waves	shiny	280	S	51 - 55
Aduro 3.0	02122 0	purple waves	shiny	300	M	52 - 58
Aduro 3.0	02123 7	purple waves	shiny	320	L	58 - 62
Aduro 3.0	90127 0	velvet black	matt	280	S	51 - 55
Aduro 3.0	90325 0	velvet black	matt	300	M	52 - 58
Aduro 3.0	90346 5	velvet black	matt	320	L	58 - 62
Aduro 3.0	90493 6	polar white	matt	280	S	51 - 55
Aduro 3.0	90628 2	polar white	matt	300	M	52 - 58
Aduro 3.0	90793 7	polar white	matt	320	L	58 - 62
Aduro 3.0	91265 8	midnight blue	shiny	280	S	51 - 55
Aduro 3.0	91268 9	midnight blue	shiny	300	M	52 - 58
Aduro 3.0	91269 6	midnight blue	shiny	320	L	58 - 62
Aduro 3.0	91270 2	titan	matt	280	S	51 - 55
Aduro 3.0	91273 3	titan	matt	300	M	52 - 58
Aduro 3.0	91277 1	titan	matt	320	L	58 - 62
Aduro 3.0	91280 1	race black	matt	280	S	51 - 55
Aduro 3.0	91281 8	race black	matt	300	M	52 - 58
Aduro 3.0	91282 5	race black	matt	320	L	58 - 62
Aduro 3.0	91285 6	glacier blue	shiny	280	S	51 - 55
Aduro 3.0	91311 2	glacier blue	shiny	300	M	52 - 58
Aduro 3.0	91380 8	glacier blue	shiny	320	L	58 - 62
Aduro 3.0	91381 5	blaze red	shiny	280	S	51 - 55
Aduro 3.0	91528 4	blaze red	shiny	300	M	52 - 58
Aduro 3.0	91715 8	blaze red	shiny	320	L	58 - 62
Aduro 3.0	91732 5	race grey	matt	280	S	51 - 55
Aduro 3.0	91733 2	race grey	matt	300	M	52 - 58
Aduro 3.0	91734 9	race grey	matt	320	L	58 - 62
Aduro 3.0	91735 6	maori blackberry	matt	280	S	51 - 55
Aduro 3.0	91736 3	maori blackberry	matt	300	M	52 - 58
Aduro 3.0	91737 0	maori blackberry	matt	320	L	58 - 62
Aduro 3.0	91738 7	white art	shiny	280	S	51 - 55
Aduro 3.0	91739 4	white art	shiny	300	M	52 - 58
Aduro 3.0	91740 0	white art	shiny	320	L	58 - 62
Aduro 3.0	02033 9	orange palm	shiny	280	S	51 - 55
Aduro 3.0	02044 5	orange palm	shiny	300	M	52 - 58
Aduro 3.0	02095 7	orange palm	shiny	320	L	58 - 62
Aduro 3.0	02549 5	signal yellow	shiny	280	S	51 - 55
Aduro 3.0	02794 9	signal yellow	shiny	300	M	52 - 58
Aduro 3.0	02850 2	signal yellow	shiny	320	L	58 - 62
USB light Aduro 3.0	02939 4	black				
ABUS Bag	78592 4	black			universal	

Urban



KIDS



YOUDROP FF



Ti silver

Page 258



moss green

Page 258



sage green

Page 258



velvet black

Page 258



midnight blue

Page 258

YOUDROP



moss green

Page 260



Ti silver

Page 260



shiny black

Page 260



icon yellow

Page 260



sage green

Page 260



wildberry red

Page 260

YOUN-I 2.0



cool grey

Page 262



velvet black

Page 262



street art

Page 262



sparkling titan

Page 262



sparkling pink

Page 262



sparkling green

Page 262



sparkling blue

Page 262



signal yellow

Page 262



polar white

Page 262



living coral

Page 262



grey star

Page 262



grey flash

Page 262



glacier blue

Page 262



flower art

Page 262



cherry heart

Page 262



blue anchor

Page 262



blaze red

Page 262



black violett

Page 262



rose gold

Page 262



midnight blue

Page 262



iced mint

Page 262

YOUN-I MIPS



Mips

velvet black

Page 264



Mips

sparkling green

Page 264



Mips

polar matt

Page 264

SKURB KID



blue sailor

Page 266



green jungle

Page 266



rose foxes

Page 266



shiny pink

Page 266



shiny green

Page 266



shiny red

Page 266



midnight blue

Page 266



goldfish orange

Page 266



shiny black

Page 266



cream summer

Page 266



white crowns

Page 266



grey stars

Page 266

SMILEY 3.0 ACE LED



pure rose

Page 268



pure mint

Page 268



pure lavender

Page 268



pure aqua

Page 268



pure white

Page 268



royal purple

Page 268



royal blue

Page 268



velvet black

Page 268

SMILEY 3.0 LED



blue car

Page 270



rose strawberry

Page 270



grey space

Page 270



blue rainbow

Page 270

SMILEY 3.0



pink butterfly

Page 272



shiny yellow

Page 272



shiny red

Page 272



shiny pink

Page 272



shiny orange

Page 272



shiny green

Page 272



shiny blue

Page 272



rose princess

Page 272



purple star

Page 272



orange monster

Page 272



grey police

Page 272



grey horse

Page 272



green robo

Page 272



green nordic

Page 272



blue whale

Page 272



blue croco

Page 272

SMOOTY 2.0



blue space

Page 274



white smiley

Page 274



pink watermelon

Page 274



purple kisses

Page 274

YOUDROP FF

VIEWS



Ti silver



Ti silver



FEATURES



Zoom Ace YouDrop



Velcro Visor



Chinguard Youdrop



Reflector

TECHNOLOGY



VERSIONS



moss green



sage green



velvet black



midnight blue

Ref. No.	EAN 4003318	Colour	Finish	Weight g	Size	Head size cm
YouDrop FF	98089 3	Ti silver	matt	430	S	48 - 55
YouDrop FF	98090 9	moss green	matt	430	S	48 - 55
YouDrop FF	03421 3	sage green	matt	430	S	48 - 55
YouDrop FF	03419 0	velvet black	matt	430	S	48 - 55
YouDrop FF	03420 6	midnight blue	matt	430	S	48 - 55



YOUDROP

VIEWS



moss green



moss green



FEATURES



Zoom Ace YouDrop



Reflector



Velcro Visor

TECHNOLOGY



VERSIONS



Ti silver



shiny black



icon yellow



sage green



wildberry red

Ref. No.	EAN 4003318	Colour	Finish	Weight g	Size	Head size cm
YouDrop	98088 6	moss green	shiny	310	S	48 - 55
YouDrop	98087 9	Ti silver	shiny	310	S	48 - 55
YouDrop	03423 7	shiny black	shiny	310	S	48 - 55
YouDrop	03426 8	icon yellow	shiny	310	S	48 - 55
YouDrop	03431 2	sage green	shiny	310	S	48 - 55
YouDrop	03425 1	wildberry red	shiny	310	S	48 - 55
ABUS Bag	78592 4	black			universal	



YOUN-I 2.0

VIEWS



cool grey



cool grey



FEATURES



Zoom Ace Urban



Buckle



LED

TECHNOLOGY



VERSIONS



Ref. No.	EAN 4003318	Colour	Finish	Weight g	Size	Head size cm
Youn-I 2.0	91890 2	cool grey	matt	240	S	48 - 54
Youn-I 2.0	91891 9	cool grey	matt	260	M	52 - 57
Youn-I 2.0	40150 3	velvet black	matt	240	S	48 - 54
Youn-I 2.0	40151 0	velvet black	matt	260	M	52 - 57
Youn-I 2.0	67047 3	street art	matt+shiny	240	S	48 - 54
Youn-I 2.0	67048 0	street art	matt+shiny	260	M	52 - 57
Youn-I 2.0	40170 1	sparkling titan	shiny	240	S	48 - 54
Youn-I 2.0	40171 8	sparkling titan	shiny	260	M	52 - 57
Youn-I 2.0	40164 0	sparkling pink	shiny	240	S	48 - 54
Youn-I 2.0	40165 7	sparkling pink	shiny	260	M	52 - 57
Youn-I 2.0	40160 2	sparkling green	shiny	240	S	48 - 54
Youn-I 2.0	40161 9	sparkling green	shiny	260	M	52 - 57
Youn-I 2.0	40158 9	sparkling blue	shiny	240	S	48 - 54
Youn-I 2.0	40159 6	sparkling blue	shiny	260	M	52 - 57
Youn-I 2.0	40162 6	signal yellow	shiny	240	S	48 - 54
Youn-I 2.0	40163 3	signal yellow	shiny	260	M	52 - 57
Youn-I 2.0	40152 7	pearl white	shiny	240	S	48 - 54
Youn-I 2.0	40153 4	pearl white	shiny	260	M	52 - 57
Youn-I 2.0	40156 5	living coral	shiny	240	S	48 - 54
Youn-I 2.0	40157 2	living coral	shiny	260	M	52 - 57
Youn-I 2.0	63810 7	grey star	matt+shiny	240	S	48 - 54
Youn-I 2.0	63811 4	grey star	matt+shiny	260	M	52 - 57
Youn-I 2.0	63812 1	grey flash	matt+shiny	240	S	48 - 54
Youn-I 2.0	63813 8	grey flash	matt+shiny	260	M	52 - 57
Youn-I 2.0	40154 1	glacier blue	shiny	240	S	48 - 54
Youn-I 2.0	40155 8	glacier blue	shiny	260	M	52 - 57
Youn-I 2.0	67045 9	flower art	matt+shiny	240	S	48 - 54
Youn-I 2.0	67046 6	flower art	matt+shiny	260	M	52 - 57
Youn-I 2.0	63808 4	cherry heart	matt+shiny	240	S	48 - 54
Youn-I 2.0	63809 1	cherry heart	matt+shiny	260	M	52 - 57
Youn-I 2.0	63814 5	blue anchor	matt+shiny	240	S	48 - 54
Youn-I 2.0	63815 2	blue anchor	matt+shiny	260	M	52 - 57
Youn-I 2.0	40168 8	blaze red	shiny	240	S	48 - 54
Youn-I 2.0	40169 5	blaze red	shiny	260	M	52 - 57
Youn-I 2.0	40166 4	black violet	shiny	240	S	48 - 54
Youn-I 2.0	40167 1	black violet	shiny	260	M	52 - 57
Youn-I 2.0	91888 9	rose gold	matt	240	S	48 - 54
Youn-I 2.0	91889 6	rose gold	matt	260	M	52 - 57
Youn-I 2.0	91885 8	midnight blue	matt	240	S	48 - 54
Youn-I 2.0	91887 2	midnight blue	matt	260	M	52 - 57
Youn-I 2.0	91892 6	iced mint	matt	240	S	48 - 54
Youn-I 2.0	91893 3	iced mint	matt	260	M	52 - 57
Light accessories USB URBAN-I 3.0/HYBAN 2.0/ YOUN-I 2.0	88781 9	black			universal	
ABUS Bag	78592 4	black			universal	



YOUN-I MIPS

VERSIONS



velvet black



velvet black



FEATURES



Zoom Evo Kids



Buckle



LED

TECHNOLOGY



VERSIONS



sparkling green



polar matt

Ref. No.	EAN 4003318	Colour	Finish	Weight g	Size	Head size cm
Youn-I MIPS	38811 8	velvet black	matt	260	S	48 - 54
Youn-I MIPS	38812 5	velvet black	matt	280	M	52 - 57
Youn-I MIPS	38813 2	sparkling green	shiny	260	S	48 - 54
Youn-I MIPS	38814 9	sparkling green	shiny	280	M	52 - 57
Youn-I MIPS	38809 5	polar matt	matt	260	S	48 - 54
Youn-I MIPS	38810 1	polar matt	matt	280	M	52 - 57
Raincap Toplight	39849 0	black			universal	
ABUS Bag	78592 4	black			universal	



SKURB KID

VIEWS



green jungle



green jungle



FEATURES



Zoom Evo Kids



Buckle



USB LED optional

TECHNOLOGY



VERSIONS



blue sailor



rose foxes



shiny pink



shiny green



shiny red



midnight blue



goldfish orange



shiny black



cream summer



white crowns



grey stars

Ref. No.	EAN 4003318	Colour	Finish	Weight g	Size	Head size cm
Skurb Kid	04772 5	green jungle	shiny	240	S	45 - 50
Skurb Kid	04774 9	green jungle	shiny	250	M	50 - 55
Skurb Kid	97846 3	blue sailor	shiny	240	S	45 - 50
Skurb Kid	97847 0	blue sailor	shiny	250	M	50 - 55
Skurb Kid	97848 7	rose foxes	shiny	240	S	45 - 50
Skurb Kid	97849 4	rose foxes	shiny	250	M	50 - 55
Skurb Kid	04452 6	shiny pink	shiny	240	S	45 - 50
Skurb Kid	04650 6	shiny pink	shiny	250	M	50 - 55
Skurb Kid	04428 1	shiny green	shiny	240	S	45 - 50
Skurb Kid	04440 3	shiny green	shiny	250	M	50 - 55
Skurb Kid	04300 0	shiny red	shiny	240	S	45 - 50
Skurb Kid	04426 7	shiny red	shiny	250	M	50 - 55
Skurb Kid	04283 6	midnight blue	shiny	240	S	45 - 50
Skurb Kid	04289 8	midnight blue	shiny	250	M	50 - 55
Skurb Kid	04677 3	goldfish orange	shiny	240	S	45 - 50
Skurb Kid	04678 0	goldfish orange	shiny	250	M	50 - 55
Skurb Kid	04296 6	shiny black	shiny	240	S	45 - 50
Skurb Kid	04298 0	shiny black	shiny	250	M	50 - 55
Skurb Kid	04679 7	cream summer	shiny	240	S	45 - 50
Skurb Kid	04680 3	cream summer	shiny	250	M	50 - 55
Skurb Kid	04681 0	white crowns	shiny	240	S	45 - 50
Skurb Kid	04718 3	white crowns	shiny	250	M	50 - 55
Skurb Kid	04744 2	grey stars	shiny	240	S	45 - 50
Skurb Kid	04746 6	grey stars	shiny	250	M	50 - 55
Spare light USB Smiley 3.0/ Skurb Kid	69445 5	black				universal
Spare light (Battery) Smiley 3.0/ Skurb Kid	91108 8	black				universal
Winter Kit Smiley	48874 0	black				S
Winter Kit Smiley	48875 7	black				M
ABUS Bag	78592 4	black				universal



SMILEY 3.0 ACE LED

VIEWS



pure rose



pure rose



FEATURES



Zoom Evo Kids



Buckle



USB LED



TECHNOLOGY



VERSIONS



pure mint



pure lavender



pure aqua



pure white



royal purple



royal blue



velvet black

Ref. No.	EAN 4003318	Colour	Finish	Weight g	Size	Head size cm
Smiley 3.0 ACE LED	40345 3	pure rose	matt+shiny	230	S	45 - 50
Smiley 3.0 ACE LED	38030 3	pure rose	matt+shiny	250	M	50 - 55
Smiley 3.0 ACE LED	38029 7	pure mint	matt+shiny	250	M	50 - 55
Smiley 3.0 ACE LED	40344 6	pure mint	matt+shiny	230	S	45 - 50
Smiley 3.0 ACE LED	94291 4	pure lavender	matt+shiny	230	S	45 - 50
Smiley 3.0 ACE LED	40915 8	pure lavender	matt+shiny	250	M	50 - 55
Smiley 3.0 ACE LED	94292 1	pure aqua	matt+shiny	230	S	45 - 50
Smiley 3.0 ACE LED	40916 5	pure aqua	matt+shiny	250	M	50 - 55
Smiley 3.0 ACE LED	94290 7	pure white	matt+shiny	230	S	45 - 50
Smiley 3.0 ACE LED	40914 1	pure white	matt+shiny	250	M	50 - 55
Smiley 3.0 ACE LED	67712 0	royal purple	shiny	230	S	45 - 50
Smiley 3.0 ACE LED	67713 7	royal purple	shiny	250	M	50 - 55
Smiley 3.0 ACE LED	67708 3	royal blue	shiny	230	S	45 - 50
Smiley 3.0 ACE LED	67709 0	royal blue	shiny	250	M	50 - 55
Smiley 3.0 ACE LED	66228 7	velvet black	matt	230	S	45 - 50
Smiley 3.0 ACE LED	66239 3	velvet black	matt	250	M	50 - 55
Spare light USB Smiley 3.0/ Skurb Kid	41039	white			universal	
Spare light USB Smiley 3.0/ Skurb Kid	69445 5	black			universal	
Winter Kit Smiley	48874 0	black			S	
Winter Kit Smiley	48875 7	black			M	
ABUS Bag	78592 4	black			universal	



SMILEY 3.0 LED

VIEWS



blue car



blue car



FEATURES



Zoom Evo Kids



Buckle



LED (battery)

TECHNOLOGY



VERSIONS



rose strawberry



grey space



blue rainbow

Ref. No.	EAN 4003318	Colour	Finish	Weight g	Size	Head size cm
Smiley 3.0 LED	67296 5	blue car	shiny	230	S	45 - 50
Smiley 3.0 LED	67297 2	blue car	shiny	250	M	50 - 55
Smiley 3.0 LED	67706 9	rose strawberry	shiny	230	S	45 - 50
Smiley 3.0 LED	67707 6	rose strawberry	shiny	250	M	50 - 55
Smiley 3.0 LED	67298 9	grey space	shiny	230	S	45 - 50
Smiley 3.0 LED	67299 6	grey space	shiny	250	M	50 - 55
Smiley 3.0 LED	67300 9	blue rainbow	shiny	230	S	45 - 50
Smiley 3.0 LED	67301 6	blue rainbow	shiny	250	M	50 - 55
Spare light USB Smiley 3.0/ Skurb Kid	69445 5	black			universal	
Winter Kit Smiley	48874 0	black			S	
Winter Kit Smiley	48875 7	black			M	
ABUS Bag	78592 4	black			universal	



SMILEY 3.0

VIEWS



pink butterfly



pink butterfly



FEATURES



Zoom Evo Kids



Buckle



USB LED (optional)

TECHNOLOGY



VERSIONS



shiny yellow



shiny red



shiny pink



shiny orange



shiny green



shiny blue



rose princess



purple star



orange monster



grey police



grey horse



green robo



green nordic



blue whale



blue croco

Ref. No.	EAN 4003318	Colour	Finish	Weight g	Size	Head size cm
Smiley 3.0	67257 6	pink butterfly	shiny	220	S	45 - 50
Smiley 3.0	67258 3	pink butterfly	shiny	240	M	50 - 55
Smiley 3.0	67277 4	shiny yellow	shiny	220	S	45 - 50
Smiley 3.0	67278 1	shiny yellow	shiny	240	M	50 - 55
Smiley 3.0	67273 6	shiny red	shiny	220	S	45 - 50
Smiley 3.0	67274 3	shiny red	shiny	240	M	50 - 55
Smiley 3.0	67271 2	shiny pink	shiny	220	S	45 - 50
Smiley 3.0	67272 9	shiny pink	shiny	240	M	50 - 55
Smiley 3.0	67275 0	shiny orange	shiny	220	S	45 - 50
Smiley 3.0	67276 7	shiny orange	shiny	240	M	50 - 55
Smiley 3.0	67279 8	shiny green	shiny	220	S	45 - 50
Smiley 3.0	67280 4	shiny green	shiny	240	M	50 - 55
Smiley 3.0	67294 1	shiny blue	shiny	220	S	45 - 50
Smiley 3.0	67295 8	shiny blue	shiny	240	M	50 - 55
Smiley 3.0	67250 7	rose princess	shiny	220	S	45 - 50
Smiley 3.0	67251 4	rose princess	shiny	240	M	50 - 55
Smiley 3.0	67259 0	purple star	shiny	220	S	45 - 50
Smiley 3.0	67260 6	purple star	shiny	240	M	50 - 55
Smiley 3.0	67265 1	orange monster	shiny	220	S	45 - 50
Smiley 3.0	67266 8	orange monster	shiny	240	M	50 - 55
Smiley 3.0	67269 9	grey police	shiny	220	S	45 - 50
Smiley 3.0	67270 5	grey police	shiny	240	M	50 - 55
Smiley 3.0	67252 1	grey horse	shiny	220	S	45 - 50
Smiley 3.0	67253 8	grey horse	shiny	240	M	50 - 55
Smiley 3.0	67267 5	green robo	shiny	220	S	45 - 50
Smiley 3.0	67268 2	green robo	shiny	240	M	50 - 55
Smiley 3.0	67255 2	green nordic	shiny	220	S	45 - 50
Smiley 3.0	67256 9	green nordic	shiny	240	M	50 - 55
Smiley 3.0	67261 3	blue whale	shiny	220	S	45 - 50
Smiley 3.0	67262 0	blue whale	shiny	240	M	50 - 55
Smiley 3.0	67263 7	blue croco	shiny	220	S	45 - 50
Smiley 3.0	67264 4	blue croco	shiny	240	M	50 - 55
Spare light USB Smiley 3.0/ Skurb Kid	69445 5	black			universal	
Spare light (Battery) Smiley 3.0/ Skurb Kid	91108 8	black			universal	
Winter Kit Smiley	48874 0	black			S	
Winter Kit Smiley	48875 7	black			M	
ABUS Bag	78592 4	black			universal	



SMOOTY 2.0

VIEWS



blue space



blue space



FEATURES



Zoom Evo Kids



Buckle

TECHNOLOGY



VERSIONS



white smiley



pink watermelon



purple kisses

Ref. No.	EAN 4003318	Colour	Finish	Weight g	Size	Head size cm
Smooty 2.0	81623 9	blue space	shiny	200	S	45 - 50
Smooty 2.0	81851 6	blue space	shiny	220	M	50 - 55
Smooty 2.0	81852 3	white smiley	shiny	200	S	45 - 50
Smooty 2.0	81853 0	white smiley	shiny	220	M	50 - 55
Smooty 2.0	81854 7	pink watermelon	shiny	200	S	45 - 50
Smooty 2.0	81855 4	pink watermelon	shiny	220	M	50 - 55
Smooty 2.0	81856 1	purple kisses	shiny	200	S	45 - 50
Smooty 2.0	81857 8	purple kisses	shiny	220	M	50 - 55
ABUS Bag	78592 4	black			universal	



HELMET ACCESSORIES



REMOTE CONTROL BRAKE LIGHT (HYP-E)



Page 278

MAGNETIC VISOR (HYP-E)



Page 278

REMOTE CONTROL INDICATOR LIGHT (HYP-E)



Page 278

EARPADS HYP-E



Page 279

**PEDELEC 2.0
EARPADS**



Page 279

WINTERKIT



Page 279

RACE CAP



Page 280

RAIN CAP



Page 280

RAIN CAP TOPLIGHT



Page 280

SPARE SHIELD



Gamechanger TT 1.1
Page 281

SPARE SHIELD

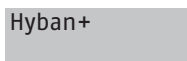

Hyban+
Page 281

SPARE SHIELD

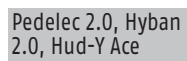

Pedelec 2.0, Hyban 2.0, Hud-Y Ace
Page 281

SPARE GLASS

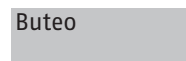

Buteo
Page 282

USB LIGHT ACCESSORIES

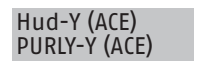

Hud-Y (ACE)
PURLY-Y (ACE)
Page 282

LIGHT ACCESSORIES



Smiley 3.0,
Skurb Kid
Page 282

USB LIGHT ACCESSORIES



Urban
Page 283

USB LIGHT ACCESSORIES

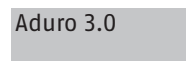

Aduro 3.0
Page 283

REFLEKTOR STICKERSET

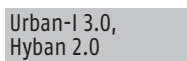
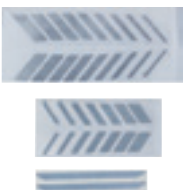

Urban-l 3.0,
Hyban 2.0
Page 284

ABUS BAG



Page 284

HELMET BAG SPORTIV

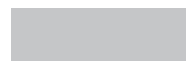

Page 284

REMOTE CONTROL BRAKE LIGHT HYP- E



TECHNICAL DATA

- Remote control for controlling the brake light for the ABUS HYP-E helmet model and the HYP-E ACE and HYP-E BL.ACE variants
- Cover for the brake lever on the handlebar
- When the brake lever is pulled, the brake light on the HYP-E is activated by a predefined pressure point
- Additional push button on the brake lever to activate the hazard warning light on the front of the helmet
- Compatible with most common brake levers for urban bikes
- Remote control is permanently ready for operation and is activated via the helmet's radio signal

Ref. No.	EAN 4003318	Colour	Size	Box Qty
Remote Control Brake Light	40429 0	black	universal	1

MAGNETIC VISOR HYP- E



clear

smoke

photochromic

TECHNICAL DATA

- Made from hard-wearing polycarbonate
- Flexibility thanks to Magnetic Hub: visor is not a permanently installed component, but can be flexibly attached, removed and replaced
- Visor for the ABUS HYP-E helmet model and the HYP-E ACE and HYP-E BL.ACE variants
- Optionally available in clear (e.g. at dusk), smoke (e.g. in bright light) or photochromic (automatically adapts to light conditions) variants
- The visor can be attached to the helmet quickly and easily using the patented Magnetic Hub
- Visor design enables clear all-round vision at any head angle

Ref. No.	EAN 4003318	Colour	Size	Box Qty
Visor clear	40947 9	clear	S/M	1
Visor smoke	94321 8	smoke	S/M	1
Visor photochromic	38062 4	photochromic	S/M	1
Visor clear	94563 2	clear	L	1
Visor smoke	41168 7	smoke	L	1
Visor photochromic	38276 5	photochromic	L	1

REMOTE CONTROL INDICATOR LIGHT (HYP- E)



TECHNICAL DATA

- LEDs on the remote control indicate when flashing is taking place by means of a visual signal
- Remote control for controlling the flashing lights for the ABUS HYP-E helmet model and the HYP-E ACE and HYP-E BL.ACE variants
- For mounting on the handlebar: simply attach to the handlebar using the supplied rubber ring
- Compatible with all standard bicycle handlebars with a diameter between 22.2 and 25.4 mm
- Equipped with arrow keys for direction indication
- Remote control is permanently ready for operation and is activated via the helmet's radio signal

Ref. No.	EAN 4003318	Colour	Size	Box Qty
Remote Control Indicator Light	38061 7			1

EARPADS HYP- E



TECHNICAL DATA

- Ear warmers for the ABUS HYP-E helmet model and the HYP-E ACE and HYP-E BL.ACE variants
- Ear muffs keep your ears warm during outdoor activities on your bike – whether in the cold, winter, rain or wind
- EarPads can be quickly and easily retrofitted to the lower edge of the bike helmet
- Soft, breathable and cushioned pads fit comfortably and snugly on the ear
- Washable at 30 degrees in a laundry bag
- Ear warmers replace a hat and ensure that the bike helmet fits securely
- The fabric structure of the EarPads ensures that ambient noise can be easily heard
- Greater visibility thanks to reflective application on the outside of the EarPads

Ref. No.	EAN 4003318	Colour	Size	Box Qty
EarPads HYP-E	40430 6	Black	universal	1

PEDELEC 2.0 EARPADS



TECHNICAL DATA

- Additional warming earmuffs which can be attached to the helmet

Ref. No.	EAN 4003318	Colour	Size	Box Qty
Earpads Pedelec 2.0	83482 0	black	universal	1

WINTER KIT



TECHNICAL DATA

- Flexible and comfortable fleece bonnet with ear protection
- Seam welded for comfortable fit

Ref. No.	EAN 4003318	Colour	Size	Box Qty
Winter Kit	48876 4	black	M	1
Winter Kit	48877 1	black	L	1
Winter Kit Smiley	48874 0	black	S	1
Winter Kit Smiley	48875 7	black	M	1

RACE CAP



autumn black



porto blue



italian white



adventure blue

TECHNICAL DATA

- 100% Made in Italy
- Large antibacterial sweatband (20 mm diameter) sewn into the Race Cap
- Elastic waistband for custom fit
- Quick-drying blended fabric made from 65% polyester and 35% cotton
- Washable at 30 degrees, not suitable for tumble dryer
- 100% polyester mesh panel in the middle
- Size S / 51-55 cm
- Size M/L / 56-61 cm
- Stylish racing cap to wear under the road bike helmet serves as protection from sun and sweat

Ref. No.	EAN 4003318	design color	Size	Head size cm	Box Qty
Race Cap	96047 5	autumn black	M/L	56 - 61	1
Race Cap	96048 2	porto blue	M/L	56 - 61	1
Race Cap	96049 9	italian white	M/L	56 - 61	1
Race Cap	96046 8	adventure blue	M/L	56 - 61	1

RAIN CAP



TECHNICAL DATA

- Elastic band for individual adjustment of the cap to the helmet size
- Universal rain cap in signal yellow colour. Shape optimised for a number of helmets, with visor in particular

Ref. No.	EAN 4003318	Colour	Size	Box Qty
Raincap	52151 5	yellow	universal	1
Raincap	52154 6	black	universal	1

RAIN CAP TOPLIGHT



TECHNICAL DATA

- Elastic band for individual adjustment of the cap to the helmet size
- Rain cap Toplight is optimized for all helmets with a high LED rear light
- Due to the transparent material the LED rear light is clearly visible

Ref. No.	EAN 4003318	Colour	Size	Box Qty
Raincap Toplight	39849 0	black	universal	1

REPLACEMENT VISOR GAMECHANGER TT 1.1



clear

smoke

chrome

TECHNICAL DATA

- Fog-free visor thanks to good ventilation and therefore always a clear view
- Magnets in the helmet and on the visor frame allow the visor to be held securely and also removed easily
- The large visor allows a clear view to the front, even when the helmet is tilted at a steep angle
- Visor available in three versions
- The visor's form-fit design allows perfect integration with the helmet and offers aerodynamic advantages

Ref. No.	EAN 4003318	Colour	Size	Box Qty
Visor	38199 7	clear	S	1
Visor	94470 3	clear	M	1
Visor	41082 6	clear	L	1
Visor	38200 0	smoke	S	1
Visor	94471 0	smoke	M	1
Visor	41083 3	smoke	L	1
Visor	38198 0	chrome	S	1
Visor	94469 7	chrome	M	1
Visor	41081 9	chrome	L	1

REPLACEMENT VISOR HYBAN +



clear

smoke

Ref. No.	EAN 4003318	Colour	Size	Box Qty
Spare visor Hyban+	76435 6	smoke	universal	1
Spare visor Hyban+	76436 3	clear	universal	1
Visor Mount Hyban+	77325 9		universal	1

REPLACEMENT VISOR PEDELEC 2.0/HYBAN 2.0 ACE/HUD-Y ACE



clear

smoke

Ref. No.	EAN 4003318	Colour	Size	Box Qty
Visor smoke Pedelec 2.0, Hyban 2.0, HUD-Y	82888 1	smoke	universal	1
Visor clear Pedelec 2.0, Hyban 2.0, HUD-Y	82889 8	clear	universal	1
Fastening visor Pedelec 2.0, Hyban 2.0, HUD-Y	82890 4		universal	1

REPLACEMENT LENS BUTEO



TECHNICAL DATA

- Anti-fog coating
- Available with clear, mirror & tinted lens

Ref. No.	EAN 4003318	Colour	Size	Box Qty
Spare glass Buteo	68934 5	clear	universal	1
Spare glass Buteo	68935 2	smoke	universal	1
Spare glass Buteo	68936 9	red chrome	universal	1
Spare glass Buteo	68937 6	black chrome	universal	1

SPARE LIGHT USB HUD-Y (ACE) /PURL-Y (ACE)



black

white

TECHNICAL DATA

- USB rechargeable LED lights for HUD-Y and PURL-Y models
- Intuitive magnetic attachment to the helmet
- Three modes: continuous, flashing, pulse

Ref. No.	EAN 4003318	Colour	Size	Box Qty
Spare light USB HUD-Y (ACE) / PURL-Y (ACE)	94421 5	white	universal	1
Spare light USB HUD-Y (ACE) / PURL-Y (ACE)	69446 2	black	universal	1

LIGHT SMILEY 3.0/ SKURB KID



Battery and USB

TECHNICAL DATA

- Optionally with battery, or USB rechargeable spare light for Smiley 3.0 and Skurb Kid helmet models
- Increases visibility in the dark and at dusk

Ref. No.	EAN 4003318	Colour	Size	Box Qty
Spare light (Battery) Smiley 3.0/ Skurb Kid	91108 8	black	universal	1
Spare light USB Smiley 3.0/ Skurb Kid	69445 5	black	universal	1
Spare light USB Smiley 3.0/ Skurb Kid	41039 0	white	universal	1

LIGHT URBAN



TECHNICAL DATA

- Rechargeable USB light
- Increases visibility in the dark and at dusk

Ref. No.	EAN 4003318	Colour	Size	Box Qty
Spare light USB 2.0 Urban	97625 4	black	universal	1

USB LIGHT ADURO 3.0



TECHNICAL DATA

- Rechargeable USB light
- 2 modes: continuous and flashing light
- Rubberised button for switching on and off and switching between modes
- IP44 splash-protection
- Micro USB port with rubber cover (USB port cover) to protect against moisture and dirt
- Approx. 1 hour charging time, approx. 2.5 hours lighting time
- 8 LEDs
- Compatible with the Aduro 3.0

Ref. No.	EAN 4003318	Colour	Size	Box Qty
USB light Aduro 3.0	02939 4	black	universal	1

REFLEKTOR STICKERSET

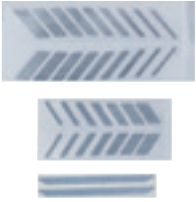

Urban-I 3.0

TECHNICAL DATA

- Reflective sticker set for the helmet to improve visibility in the dark and at dusk

Ref. No.	EAN 4003318	Colour	Size	Box Qty
Reflector Stickerset Urban-I 3.0	88782 6	silver		1
Reflector Stickerset Hyban 2.0	88783 3	silver		1

ABUS BAG



TECHNICAL DATA

- Helmet bag with logo print for the protected transport of a bicycle helmet
- Inside pocket is made from protective fleece

Ref. No.	EAN 4003318	Colour	Size	Box Qty
ABUS Bag	78592 4	black	universal	1

HELMET BAG SPORTIV



Ref. No.	EAN 4003318	Colour	Size	Box Qty
Helmet bag sportiv	68451 7	black	universal	1





LUMINO



**LUMINO
NIGHT VEST**



yellow

Page 288

**LUMINO
DAY VEST**



red

Page 288

URBAN VEST



silver

Page 289

REFLEX VEST



yellow

Page 289

URBAN VEST KIDS



silver

Page 290

REFLEX VEST KIDS



yellow

Page 290

NIGHT COVER



yellow

Page 292

X-URBAN COVER



yellow/silver

Page 292

REFLEX WRAP



yellow

Page 293

EASY MAGNET LIGHT



yellow

Page 294

INDICATOR LIGHT



yellow

Page 294

ACTIVE BAR



yellow/black

Page 295

RAINCAP



yellow

Page 295



black

Page 295

LUMINO NIGHT VEST

FEATURES



TECHNICAL DATA

- 100% polyester
- Silver applications light up as soon as light hits them
- UV-resistant material glows even after years of use
- Visibility of 150 metres at night and 100 metres during the day
- With integrated USB rear light consisting of four powerful red LEDs - rechargeable via USB port
- LED light runs for up to 10 hours (activate continuous and flashing light functions at the touch of a button)
- Additional pocket with zip on the front of the vest
- Tested according to European standard EN 1150:1999
- Extended back and good fit due to body fit

Ref. No.	EAN 4003318	Colour	Size	Box Qty
Lumino Night Vest yellow M	96020 8	yellow	M	1
Lumino Night Vest yellow L	96021 5	yellow	L	1
Lumino Night Vest yellow XL	96022 2	yellow	XL	1
Lumino Night Vest yellow XXL	96023 9	yellow	XXL	1
Lumino Night Vest yellow XXXL	96024 6	yellow	XXXL	1

LUMINO DAY VEST



TECHNICAL DATA

- 100% polyester
- Fluorescent red material lights up as soon as light hits it
- UV-resistant material glows even after years of use.
- Four highly reflective stripes for very good visibility at night, but also very good visibility during the day.
- Visibility of 150 metres at night and 100 metres during the day
- Tab on the back of the waistcoat to attach a separate light (Easy Magnet Light/Indicator Light)
- Tested according to European Standard EN 17353:2020 (AB3)
- Extended back and good fit

Ref. No.	EAN 4003318	Colour	Size	Box Qty
Lumino Day Vest red M	96026 0	red	M	1
Lumino Day Vest red L	96027 7	red	L	1
Lumino Day Vest red XL	96028 4	red	XL	1
Lumino Day Vest red XXL	96029 1	red	XXL	1
Lumino Day Vest red XXXL	96031 4	red	XXXL	1

LUMINO URBAN VEST



TECHNICAL DATA

- 100% polyester
- Fully reflective safety vest: Almost the entire surface of the safety vest is brightly illuminated by headlights.
- Colour coordinated stripes
- Visibility of 150 metres in the dark
- Tested according to European Standard EN 17353:2020 (B3)
- Tab on the back of the waistcoat to attach a separate light (Easy Magnet Light/Indicator Light)
- Extended back and good fit

Ref. No.	EAN 4003318	Colour	Size	Box Qty
Lumino Urban Vest silver M	69937 5	silver	M	1
Lumino Urban Vest silver L	69938 2	silver	L	1
Lumino Urban Vest silver XL	69944 3	silver	XL	1
Lumino Urban Vest silver XXL	90943 6	silver	XXL	1
Lumino Urban Vest silver XXXL	96034 5	silver	XXXL	1

LUMINO REFLEX VEST



TECHNICAL DATA

- 100% polyester
- Fluorescent yellow material lights up as soon as light hits it
- UV-resistant material glows even after years of use.
- Four highly reflective stripes for very good visibility at night, but also very good visibility during the day.
- Visibility of 150 metres at night and 100 metres during the day
- Tab on the back of the waistcoat to attach a separate light (Easy Magnet Light/Indicator Light)
- Tested according to European Standard EN 17353:2020 (AB3)
- Extended back and good fit

Ref. No.	EAN 4003318	Colour	Size	Box Qty
Lumino Reflex Vest yellow M	69928 3	yellow	M	1
Lumino Reflex Vest yellow L	69935 1	yellow	L	1
Lumino Reflex Vest yellow XL	69936 8	yellow	XL	1
Lumino Reflex Vest yellow XXL	90942 9	yellow	XXL	1
Lumino Reflex Vest yellow XXXL	96033 8	yellow	XXXL	1

LUMINO URBAN VEST KIDS



TECHNICAL DATA

- 100% polyester
- Fully reflective safety vest: Almost the entire surface of the safety vest is brightly illuminated by headlights.
- Colour coordinated stripes
- Visibility of 150 metres in the dark
- Tested according to European Standard EN 17353:2020 (B3)
- Excellent fit thanks to smooth-running branded zip

Ref. No.	EAN 4003318	Colour	Size	Box Qty
Lumino Urban Vest Kids silver S	69948 1	silver	S	1
Lumino Urban Vest Kids silver M	69949 8	silver	M	1
Lumino Urban Vest Kids silver L	69950 4	silver	L	1

LUMINO REFLEX VEST KIDS



TECHNICAL DATA

- 100% polyester
- Fluorescent yellow material lights up as soon as light hits it
- UV-resistant material glows even after years of use.
- Four highly reflective stripes for very good visibility at night, but also very good visibility during the day.
- Visibility of 150 metres at night and 100 metres during the day
- Excellent fit thanks to smooth-running branded zip
- Tested according to European Standard EN 17353:2020 (AB3)

Ref. No.	EAN 4003318	Colour	Size	Box Qty
Lumino Reflex Vest Kids yellow S	69945 0	yellow	S	1
Lumino Reflex Vest Kids yellow M	69946 7	yellow	M	1
Lumino Reflex Vest Kids yellow L	69947 4	yellow	L	1



LUMINO NIGHT COVER



TECHNICAL DATA

- Rain cover with integrated USB backlight - made of four powerful red LEDs
- Continuous and flashing light function at the touch of a button
- Rechargeable via USB port
- LED light runs for up to 10 hours (after charging)
- 2 adjustable elastic straps for fitting to the backpack
- Visibility of 150 metres at night and 100 metres during the day
- Good workmanship thanks to welded seams
- Waterproof rain cover

Ref. No.	EAN	Colour	Box Qty
Lumino Night Cover yellow	4003318 69954 2	yellow	1

LUMINO X- URBAN COVER



TECHNICAL DATA

- Fluorescent yellow material lights up as soon as light hits it
- Highly reflective stripes for very good visibility at night, but also very good visibility during the day.
- Visibility of 150 metres at night and 100 metres during the day
- 2 adjustable elastic straps for fitting to the backpack
- Highly waterproof and durable thanks to welded seams
- Waterproof rain cover

Ref. No.	EAN	Colour	Box Qty
Lumino X-Urban Cover yellow/silver	4003318 69955 9	yellow/silver	1

LUMINO REFLEX WRAP



TECHNICAL DATA

- Fluorescent yellow material lights up as soon as light hits it
- Two highly reflective stripes for very good visibility at night, but also very good visibility during the day.
- UV-resistant material (meets the requirements of the European standard EN2471) shines even after years of use.
- Visibility of 150 metres at night and 100 metres during the day
- Flexible thanks to Velcro fastener (from approx. 82 to 108 cm circumference)

Ref. No.

EAN
4003318

Colour

Box
Qty

Lumino Reflex Wrap yellow

69952 8

yellow

1



LUMINO EASY MAGNET LIGHT



TECHNICAL DATA

- Continuous light and flashing light function at the touch of a button
- Rechargeable via micro USB
- High-quality high-gloss material, yellow with 4 red LEDs
- The luminous band closes easily with the magnetic clasp
- LED light runs for up to 10 hours (after charging)
- Suitable for rainy weather thanks to fully welded-in, waterproof exterior
- Visibility of 150 metres at night and 100 metres during the day
- Tested according to European standard EN 13356:2001

Ref. No.

EAN
4003318

Colour

Box Qty

Lumino Easy Magnet Light yellow

69960 3

yellow

1

LUMINO INDICATOR LIGHT



TECHNICAL DATA

- Continuous and flashing light function at the touch of a button
- Incl. replaceable battery CR2032
- High-quality high-gloss material, yellow with 4 red, powerful LEDs
- With practical Velcro fastener for attaching to various objects
- Light runs up to 100 hours
- Suitable for rainy weather thanks to fully welded-in, waterproof exterior

Ref. No.

EAN
4003318

Colour

Box Qty

Lumino Indicator Light yellow

69958 0

yellow

1

LUMINO ACTIVE BAR



TECHNICAL DATA

- Continuous and flashing light function at the touch of a button
- Incl. replaceable battery CR2032
- Light runs up to 100 hours
- Suitable for rainy weather thanks to fully welded-in, waterproof exterior
- Tested according to European standard EN 13356:2001
- Visibility of 150 metres at night and 100 metres during the day

Ref. No.	EAN 4003318	Colour	Box Qty
Lumino Active Bar yellow/black	69957 3	yellow/black	1

RAIN CAP



TECHNICAL DATA

- Elastic band for individual adjustment of the cap to the helmet size

Ref. No.	EAN 4003318	Colour	Size	Box Qty
Raincap	52151 5	yellow	universal	1
Raincap	52154 6	black	universal	1

SUCCESSFUL SHOP DESIGN

How you design your shop is a significant part of your economic success from a psychological perspective. We help you in the process of making your showroom a customer-friendly area. By doing so, you do not only ensure successful sales today, but also in the future. Because your customers will always come back.

1. STAND OUT

Make your business stand out from the crowd and ensure that your customers feel comfortable in your shop with a warm atmosphere.

2. QUALITY WINS

Many years of experience, carefully thought out development processes and high-quality materials are significant for the products themselves as well as for the presentation aids. ABUS has the complete package.

3. BE REMEMBERED

Create experiences, that go beyond the simple provision and sale of goods. Touch, try out - go on a discovery tour. This is your advantage especially compared to online businesses.



WE SUPPORT YOU IN SELLING OUR PRODUCTS

Your needs are very important to us. We support you in the process of creating experiences and transforming the purchase into an event, which you like to think back to - and that you want to repeat.

MODULAR CONSTRUCTION:

Our new system is designed in such a way that it can be assembled in a modular way from various elements. You can influence the design.

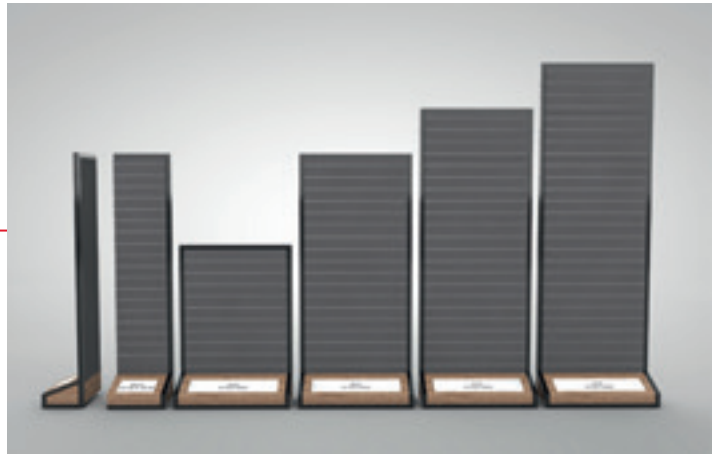

NUMEROUS ADD-ONS:

Attract attention, help to categorize and inform - combine the tools just the way you need them.



MODERN DESIGN:

Metal and wood elements combined in an understated „handmade“ look - won't disrupt the existing design of your shop.

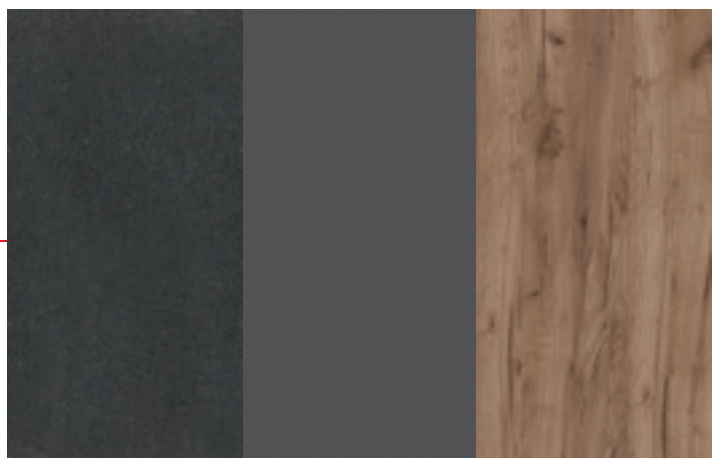

Powder coating
DB703 micro-
structure

Graphite Grey
Kronospan Decor
0162

Tobacco Craft Oak
Kronospan Decor
K004

WALL DISPLAY

Make full use of height and width of your walls to draw attention to the products. The combination of a solid base and stable back/rear wall ensures a secure stand.



WALL DISPLAY DIMENSIONS:

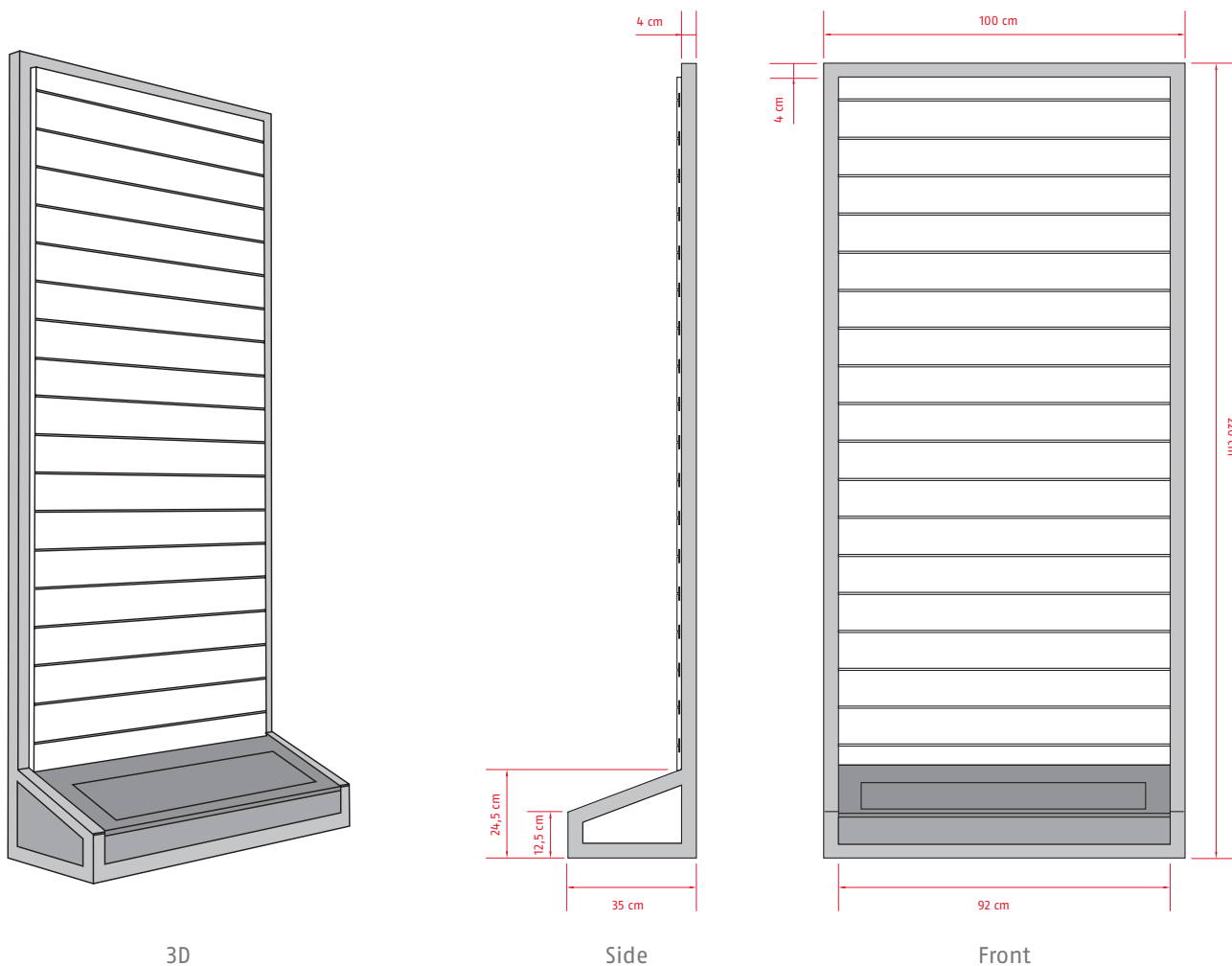

3D

Side

Front

FEATURES WALL DISPLAY:

Available in 100 cm or 50 cm width, depth 35 cm

Height: 140-260 cm (variable in 40-cm-steps thanks to additional spacers)

Slatwall with option for power supply for lighting etc.



Base in wood look with interchangeable inlays

Optional with removable lid (usable as storage space)

Choose from our range of full-surface, illuminated picture elements

DIMENSIONS FREE-STANDING DISPLAY:

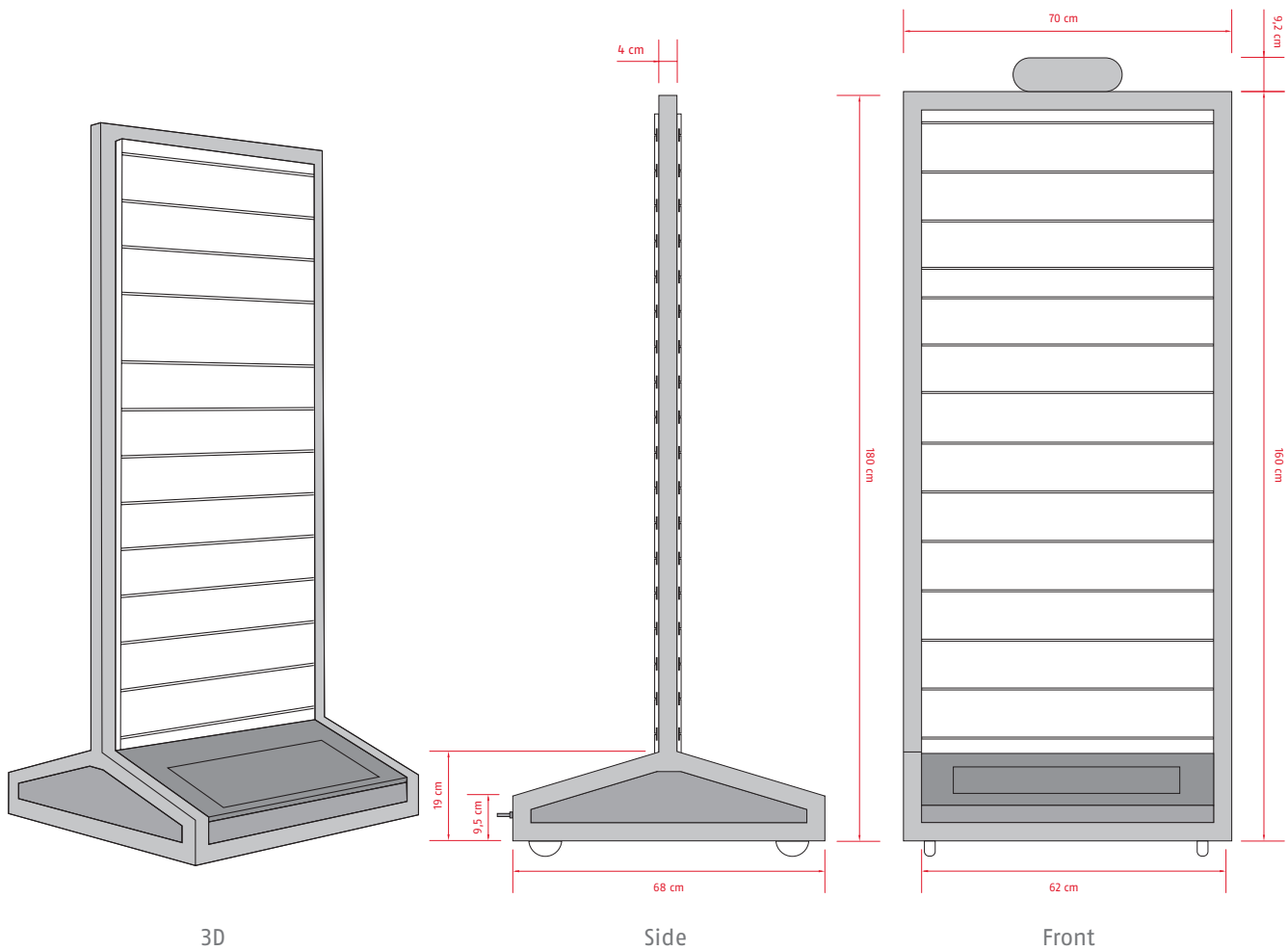

FREE STANDING DISPLAY

Expand and structure your product categories with free-standing displays - for example for new products or special offers. Thanks to the optional caster wheels you can move the display at any time to a new location.



Both sides can be used for display

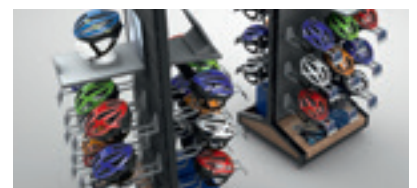

Optional & removeable cover, can be used for storage



Optional caster wheels make repositioning easy



BE INSPIRED

Our new product presentation system offers a wide range of possible combinations. You can choose and equip your displays to match your product range and your premises.



Very good balance of merchandising density and matching picture elements

Easy/simple orientation via category signs

Large selection of illuminated picture elements for the tension frames



Inserts with product information as a decision-making aid

Order and clarity thanks to storage space in the base

INDEX

Ref. No.	Page	Ref. No.	Page	Ref. No.	Page
Locks		Locks		Brackets and Bags	
57 Touch	131	GRANIT™ WBA 75	119	Basico ST 5200	154
64 TITALIUM™	133	INFINITY LOOP 1806	62	Bracket EaZy KF™	141
70 & 70IB	134	IVEN Chain 8210	52	Bracket Fidlock FL	150
145	132	IVEN Steel-0-Flex™ 8200	76	Bracket Fidlock TexFL	150
147TSA	135	IVERA Cable 7220	93	Bracket GH 50	142
402	25	IVERA Chain 7210	54	Bracket IVERA RBU	148
1200 Web	69	IVERA Chain 7210 Color	55	Bracket Quick Store QST	148
1500 Web	69	IVERA Steel-0-Flex™ 7200	77	Bracket QuickSnap RBU	151
1850	125	IVY Chain 9210	49	Bracket Saddlefix SH SF	143
3406C	97	IvyTex Adaptor Chain	109	Bracket SCLL	150
3406K	97	Kette 6KS Loop	124	Bracket SH 5700 BORDO™	145
3506C	91	KeyGarage™ 767	131	Bracket SH 5700 uGrip BORDO™ BIG	146
3506K	91	KeyGarage™ 787	129	Bracket SH 6000 BORDO™	144
4408C	96	KeyGarage™ 787 BIG	128	Bracket SH 6000 BORDO™ BIG	145
4408K	96	KeyGarage™ 787 BIG LED	128	Bracket SH 6055 BORDO™ Lite	146
4650S / SL	106	KeyGarage™ 787 LED	129	Bracket SH 6200K	144
4650X / XL	106	KeyGarage™ 787 ONE	127	Bracket SH 6500 BORDO XPlus™	144
4204K Goose Lock	73	KeyGarage™ 797	130	Bracket SH 6500A ONE	143
6206K Goose Lock	72	KeyGarage™ 797 LED	130	Bracket SH 6500K BORDO™	143
8808C	53	KeyGarage™ 797 ONE	127	Bracket SH B	140
ACH 2.0 Adaptor Chain	108	Microflex 6615K	81	Bracket SH FL	145
ACL ADAPTOR CABLE	108	Numerino 5410C	95	Bracket SH 6055 Selle Royal	146
Alarmbox 2.0	117	Número 5510C	89	Bracket Snap Cage	149
Alarmbox RC	117	PHANTOM™ 8950	86	Bracket ST 5700 uGrip BORDO™	147
Booster 6512K	88	PHANTOM™ 8960	78	Bracket ST 6000 BORDO™	147
BORDO GRANIT™ 6500K	32	Primo 5410K	95	Bracket ST 6000 BORDO™ BIG	147
BORDO GRANIT™ 6500KA	31	Primo 5510K	89	Bracket TexKF Mini	151
BORDO™ 6000C	38	PRO AMPARO 4750 S / SL	105	Bracket UGH 02	142
BORDO™ 6000C LED	39	PRO AMPARO 4750 X / XL	104	Bracket USH 540 / 470 / 460	141
BORDO™ 6000K	37	PRO TECTIC™ 4960	107	Bracket USKF	140
BORDO™ 6000KA	36	PS88	126	Chain Bag ST 2012	149
BORDO™ 6200K	33	Racer 6412K	94	Clutching Strap LH adaptor	152
BORDO™ Lite 6055C	43	Raydo Pro 1450	87	FMU 6950	151
BORDO™ Lite 6055C Mini	43	Sportflex 2504	122	Oryde ST 2085	153
BORDO™ Lite 6055K	42	Star 4508C	90	Oryde ST 2100	154
BORDO™ Lite 6055K Mini	42	Star 4508K	90	Oryde ST 2200	153
BORDO™ One 6000A	35	Steel-0-Chain™ 4804C	68	Oryde ST 2250	153
BORDO™ One 6000A FINGERPRINT	34	Steel-0-Chain™ 4804C SYMBOLS	68	Shackle Clamp	142
BORDO™ One 6500A	30	Steel-0-Chain™ 4804K	67	ST 1010	152
Catena 6806K	64	Steel-0-Chain™ 5805C	66	ST 5050	152
Catena 6806 Color	65	Steel-0-Chain™ 5805K	66	ST 5850/5650/4960	149
Catena 6806K Neon	64	Steel-0-Chain™ 8807K	58	ST 5950 2.0	154
Catena 6806K Reflective	65	Steel-0-Chain™ 9808K	51		
Centuro 860	77	Steel-0-Chain™ 9809K	51		
Chain Claw 10	116	Steel-0-Flex™ 950	76		
CityChain™ 1010	50	Steel-0-Flex™ Raydo Pro 1460	79		
Cobra™	125	Steel-0-Flex™ Tresor 1360	80		
Combiflex™	122	TECTIC™ 496	107		
Combiflex™ Adventure	123	Tresor 1385	59		
Combiflex™ Travelguard	123	Tresor 1385 Color	60		
Combiloop 205	124	Tresor 1385 Neon	61		
Diskus® 20	135	Tresor 6412C	94		
Diskus® 24IB	134	Tresor 6512C	88		
Facilo 32	25	Tresorflex 6615C	81		
Firestop AFS625	126	uGrip BORDO™ 5700 Combo	41		
GRANIT CityChain XPlus™ 1060	48	uGrip BORDO™ 5700K	40		
GRANIT XPlus™ 540	18	Ultimate 420K	21		
GRANIT XPlus™ 6950	102	Ultra 410K	24		
GRANIT™ 460	22	WA 50	121		
GRANIT™ Extreme 59	16	WBA 60	121		
GRANIT™ Plus 470	20	WBA 65	120		
GRANIT™ Plus 640	19	WCH90	118		
GRANIT™ Super Extreme 2500	17	YARDO 7807F	56		
GRANIT™ WBA 100	119				

INDEX

Ref. No.	Page	Ref. No.	Page	Ref. No.	Page
Helmets		Helmets		Lumino	
ABUS Bag	284	XOXO Eco	244 - 245	Active Bar	295
Aduro 3.0	252 - 253	YouDrop	260 - 261	Easy Magnet Light	294
Aduro 3.0 LED	250 - 251	YouDrop FF	258 - 259	Indicator Light	294
AirBreaker	170 - 171	Youn-I 2.0	262 - 263	Lumino Day Vest	288
AirDrop	190 - 191	Youn-I MIPS	264 - 265	Lumino Night Vest	288
Buteo	204 - 205			Night Cover	292
Buteo Spare Glass	282			Raincap	295
CliffHanger	194 - 195			Reflex Vest	289
Earpads (HYP-E)	279			Reflex Vest Kids	290
GameChanger 2.0	174 - 175			Reflex Wrap	293
GameChanger TT 1.1	172 - 173			Urban Vest	289
GameChanger TT 1.1 accessories visor	281			Urban Vest Kids	290
Helmet bag sportiv	284			X-Urban Cover	292
HiDrop	192 - 193				
HUD-Y	226 - 227				
HUD-Y ACE	224 - 225				
Hyban 2.0	240 - 241				
Hyban 2.0 ACE	238 - 239				
Hyban 2.0 LED	236 - 237				
Hyban+ accessories visor	281				
Hype-E	218 - 219				
Hype-E ACE	216 - 217				
Hype-E BL.ACE	214 - 215				
Indy	202 - 203				
Light accessories	283				
Light accessories	282				
Light accessories	283				
Light accessories USB HUD-Y (Ace)/ PURL-Y (Ace)	282				
Macator	184 - 185				
Magnetic Visor (HYP-E)	278				
MoDrop	198 - 199				
MoTrip	200 - 201				
Moventor 2.0	196 - 197				
Pedelec 2.0	222 - 223				
Pedelec 2.0 ACE	220 - 221				
Pedelec 2.0 Earpads	279				
Pedelec 2.0/Hyban 2.0/HUD-Y ACE visor	281				
PowerDome	180 - 181				
PowerDome ACE	178 - 179				
PURL-Y	234 - 235				
PURL-Y ACE	232 - 233				
Race Cap	280				
Rain Cap	280				
Rain Cap Toplight	280				
Reflector Stickerset	284				
Remote Control Brake Light (HYPE-E)	278				
Remote Control Indicator Light (HYPE-E)	278				
Skurb	248 - 249				
Skurb ACE	246 - 247				
Skurb Kid	266 - 267				
Smiley 3.0	272 - 273				
Smiley 3.0 ACE LED	268 - 269				
Smiley 3.0 LED	270 - 271				
Smooty 2.0	274 - 275				
StormChaser ACE	176 - 177				
Urban-I 3.0	230 - 231				
Urban-I 3.0 ACE	228 - 229				
WingBack	182 - 183				
Winter Kit	279				
XOXO	242 - 243				

GENERAL TERMS AND CONDITIONS

1. General

- 1.1 For all business relations between the customer and us the following terms and conditions apply unless otherwise agreed explicitly in writing.
- 1.2 Our offers are non-binding and only take effect with our written order confirmation or if we have arranged delivery of the ordered goods. The acknowledgement of receipt of an order does not constitute a legally binding acceptance of an offer. Drawings, illustrations, measurements, weights or other kinds of performance data are only binding if this is expressly agreed in writing. Commercial deviations and deviations caused by legal regulations or technical innovations, as well as replacement of parts by equal parts are acceptable as long as they do not adversely affect the usability of the contractual intended purpose.

2. Delivery

- 2.1 The delivery time is only agreed as approximate. It begins on the day on which the order confirmation is sent and is deemed to have been met if the goods have left our factory at the agreed time or, if it is not possible to send the order, the customer has been informed of the readiness for dispatch. In the event of delay an appropriate grace period must be set. Partial deliveries are allowed to a reasonable extent.
- 2.2 If we are prevented from fulfilling our delivery obligation by the occurrence of unforeseen or exceptional events that we were not able to avert despite due diligence in accordance with the circumstances of the individual case, e.g. official interventions, operating faults, force majeure, epidemics, global pandemics with impact on the supply chain, delay in the delivery of raw materials, etc. the delivery time shall be extended to a reasonable extent. If the delivery or service is not possible due to the above-mentioned events we will be released from our delivery obligation without the customer being able to cancel their contract or claim damages.
- 2.3 Unless otherwise expressly agreed, we shall deliver "Ex Works" (Incoterms® 2020). If delivery "Ex Works" (Incoterms® 2020) is agreed the risk will pass to the customer as soon as the consignment has been handed over to the person handling the transport or has left our warehouse for dispatch.

3. Pricing

- 3.1 Unless otherwise expressly agreed our prices are net Ex Works (Wetter /Ruhr) and include packaging and dispatch.
- 3.2 In the case of a third-party delivery for which the customer has agreed the direct delivery of the goods they have ordered to their customer we charge additional EUR 14.90 net per delivery within Germany, EUR 19.90 net per delivery within the EU.
- 3.3 Minor and minimal orders will be charged for at a proportion of costs from the current pricelist.
- 3.4 Orders for which fixed prices have not been expressly agreed will be charged in accordance with the prices valid on the day of delivery.
- 3.5 The prices of purchased items are quoted plus VAT. Changes to the rate of VAT entitle both parties to adjust their prices accordingly.
- 3.6 In the case of fixed prices agreed within the context of longer-term contracts, should a significant change of price factors occur, e.g. the price of raw materials, wages and salaries, the underlying exchange rate, etc. we can change the price accordingly.

4. Payment conditions

- 4.1 Our invoices are payable within 30 days net. If the customer concluded a SEPA Direct Debit agreement with us we grant a 2% discount for invoices covered by it.
- 4.2 No discount may be claimed if there are outstanding invoices to be paid. If an invoice paid with a credit note was calculated with a discount, we are entitled to deduct an appropriate discount deduction from the value of the credit note.
- 4.3 The customer is obliged to check our invoice immediately after receipt. The customer must raise any objections in writing to us within six weeks of receiving the invoice. The invoice will be deemed to be accepted after this period has elapsed.
- 4.4 If the credit term is exceeded we are entitled to charge default interest pursuant to Section 288 German Civil Code (BGB).
- 4.5 We are entitled to offset payments of the customer against their older debts first and will inform the customer about the nature of the offsetting. If costs and interest have already accrued, we will be entitled to offset payments against the costs first, then against the interest and finally against the main service.
- 4.6 A payment will only be deemed as having been made once we have access to the amount. In the case of cheques, payment is only deemed to have been made once the cheque has cleared. Bills of exchange will only be accepted on account of payment by arrangement and under the condition that they can be discounted. Discount charges will be calculated from the due date of the invoiced amount. Discount deductions are excluded.
- 4.7 If, after conclusion of the contract, a significant risk arises in respect of payments due to us, we will be entitled to demand a prepayment or security and to refuse the delivery until our requirements have been met.
- 4.8 Offset and retention rights are only available to the customer if their counter-claims have been legally established, are undisputed or have been recognised by us. The customer can only claim a retention right on the basis of counter-claims arising from the same delivery/service.

5. Return of goods

- 5.1 Returns of goods are only possible if they have been expressly agreed on a case-by-case basis. Goods must be returned in their original packaging and be free from freight charges.
- 5.2 For all goods returned we charge a flat-rate processing fee of 20% of the customer's product purchase price. If the cost of processing is higher, this will be invoiced separately.
- 5.3 Custom-made products as well as faulty or damaged goods are categorically excluded from returns. This also applies to products that we no longer have or have in a modified form in our range.

6. Reservation of title

- 6.1 The goods remain our property until all claims arising from the business relationship have been paid. The inclusion of individual claims in a current invoice as well as the balancing and its recognition shall not affect the reservation of title.

- 6.2 The customer is entitled to resell the goods delivered by us in the proper course of business as long as they fulfil their obligations arising from the business relationship. The customer may, however, neither pledge the reserved goods nor assign them as security. The customer is bound to secure our rights on resale of the reserved goods on credit.
- 6.3 The customer is obliged to handle the item with care; in particular they are obliged, at their own cost, to adequately insure it against fire, water damage and theft at their original value. Provided that maintenance and inspection work is required, the customer must carry this out promptly and at their own expense.
- 6.4 We are entitled at any time to request the surrender of reserved goods if the customer is in default of payment.
- 6.5 If the customer sells the reserved goods on credit, and thereby assigns to us the claims resulting from this resale of the goods, we shall accept this assignment. The client is entitled to collect claims as long as they fulfil their obligations towards. The client is entitled, at our request, to name the third-party debtors and notify them of the assignment.
- 6.6 We undertake to release the securities, in accordance with the aforementioned provisions, at our choice at the customer's request insofar as their value exceeds the claims to be secured by 20%.
- 6.7 The customer must inform us immediately about any third-party enforcement measures against the reserved goods or any claims assigned to us or other securities and indeed hand over any documents necessary for an intervention.

7. Warranty and liability

- 7.1 Obvious defects must be notified in writing immediately after receipt of delivery, hidden defects must be notified in writing immediately after their discovery.
- 7.2 In the case of defectiveness of the purchased item we have first the right to rectification whereby we can refuse the rectification alternative chosen by the customer under the requirements of Section 439 para. 3 of the German Civil Code (BGB). If we refuse both types of rectification in accordance with Section 439 para. 3 of the BGB or insofar as the rectification failed or is not acceptable to the customer, the customer is entitled to further claims for damages in place of rectification and withdrawal. A rectification is deemed to have failed after the second unsuccessful attempt unless, in particular, the nature of the item or the defect or other circumstances indicate otherwise. Any claim for damages made by the customer in place of performance is, in the case of negligent breach of duty by us or our vicarious agents, limited to foreseeable damage typical of the contract.
- 7.3 No warranty is assumed for damage caused by inappropriate or improper use, defective assembly or commissioning by the customer or a third party, natural wear and tear or negligent handling or maintenance, unsuitable operating equipment or replacement materials, defective fitting, chemical, electro-chemical or electrical influences or other influences, (e.g. water, frost, heat). Our warranty obligations also do not apply, if on the part of the customer or a third party, repairs, damage or changes are undertaken without our consent that have a causal connection with the defect being claimed for.
- 7.4 The warranty is valid for one year from the date of delivery of the item purchased.
- 7.5 Our technical advice, both orally and in writing and proposals, calculations, project plans, etc. should outline only the best possible use of our products to the customer. This does not release the customer from their obligation to examine the products themselves in order to ensure that they are satisfied with their suitability for their intended purpose.
- 7.6 Complaints of any kind can only be taken into consideration if they are communicated in writing within 10 days of receipt of the shipment. In the case of defects that are not immediately obvious, they must be communicated in writing immediately after they have been identified, within six months after receipt at the latest. In the case of delayed notification of defects all warranty claims are excluded.
- 7.7 Unless otherwise expressly agreed, compensation claims from the customer against us for whatever legal reason, in particular due to the violation of contractual obligations and unlawful acts are excluded. This shall not apply in cases of intent, gross negligence (of owners, legal representatives or senior employees) or fraudulent intent and in the case of liability according to the German Product Liability Act or due to culpable injury to life, body or health or due to culpable violation of essential contractual obligations. Provided that none of the other above-mentioned cases exists, the claim for damages for the violation of essential contractual obligations is, however, limited to foreseeable damages typical of the contract.

8. Property rights

- 8.1 The proposals, offers, illustrations, drawings, calculations and other documents produced by us in any form are our intellectual property and are therefore to be treated as confidential. You may only bring these to the attention of a third party with our consent.
- 8.2 The operating materials manufactured by us for the production of the contractual objects on behalf of the customer, in particular tools, devices, documents, etc. remain our property even if the contractual relationship comes to an end and will only be delivered to the customer after the contract has been terminated if they were invoiced separately.
- 8.3 The customer is solely liable if, by the execution of his order, rights, in particular industrial property rights of a third party, are violated.

9. Place of execution and court of jurisdiction

- 9.1 If one or more terms of these terms and conditions of purchase proves wholly or partly invalid or incomplete, this shall not affect the validity of the remaining terms. The contracting parties shall make every effort to replace the invalid term with one with the same economic intent. The same applies in the event of a loophole.
- 9.2 The business relationship with the customer shall be governed exclusively by the law of the Federal Republic of Germany to the exclusion of the United Nations Treaty on the International Sale of Goods (CISG), dated 11 April 1980.
- 9.3 The place of execution for all obligations arising from the contractual relationship is Wetter / Ruhr, Germany.
- 9.4 ABUS and the customer shall first attempt to resolve all disputes arising from or in relation to the contractual relationship between them out of court. If an out-of-court solution is not possible, Wetter / Ruhr shall be the exclusive place of jurisdiction. ABUS reserves the right to sue the customer at its registered place of business.



Security Tech Germany



© ABUS | August Bremicker Söhne KG
abus.com

Altenhofer Weg 25
58300 Wetter | Germany
mobile@abus.be

Printed on paper from sustainable forests.
Due to a policy of continual development, ABUS reserves the right to modify technical details & colours. E&OE ABUS © 2024

